

A faint, white line-art illustration of a large, classical-style building with many windows and a central entrance, serving as a background for the text.

MOL.911

Molecular Biotechnology I

Cloning and Expression

Recombinant DNA Technology (Cloning)

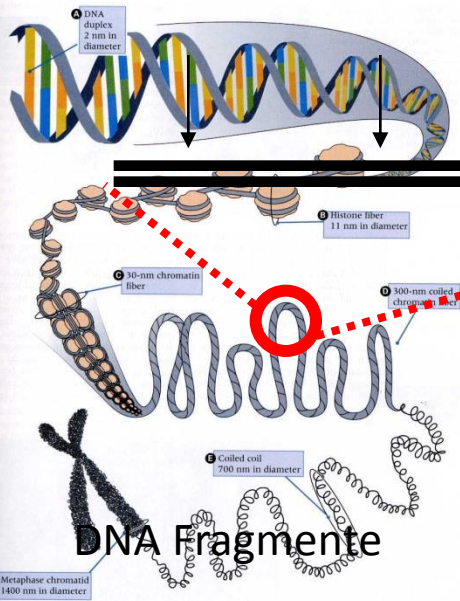

Creating defined Gene Elements – DNA Fragments

Combine Fragments with Vector

Construct proper Vectors

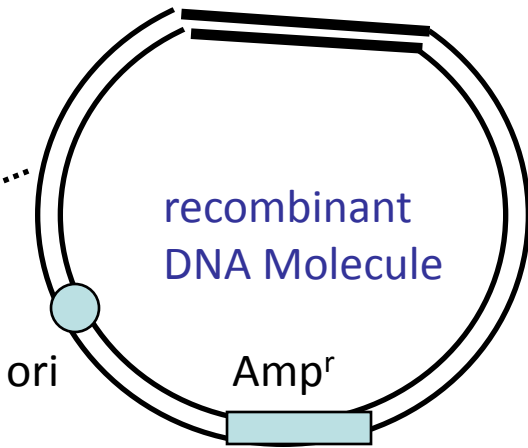
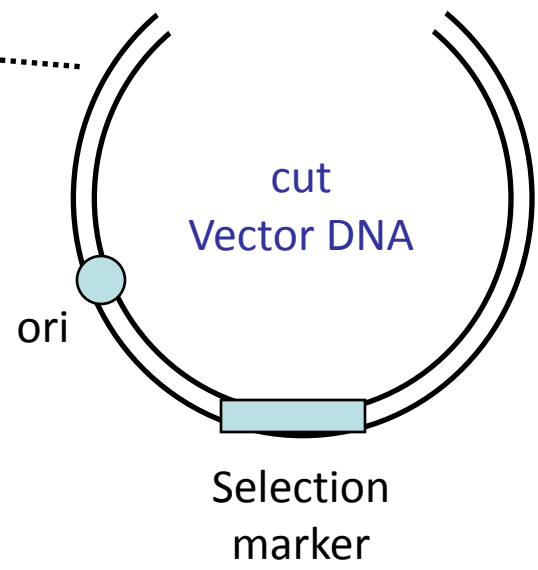
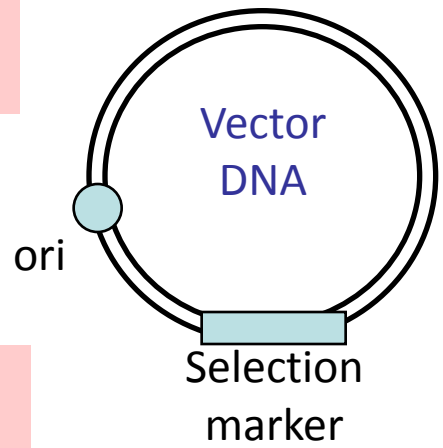

Transfer in Living Cells

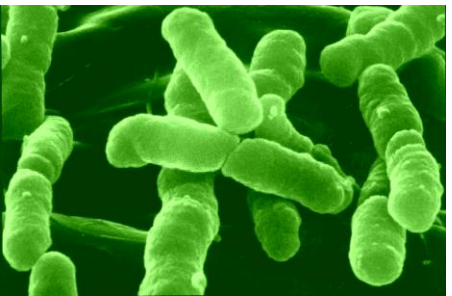
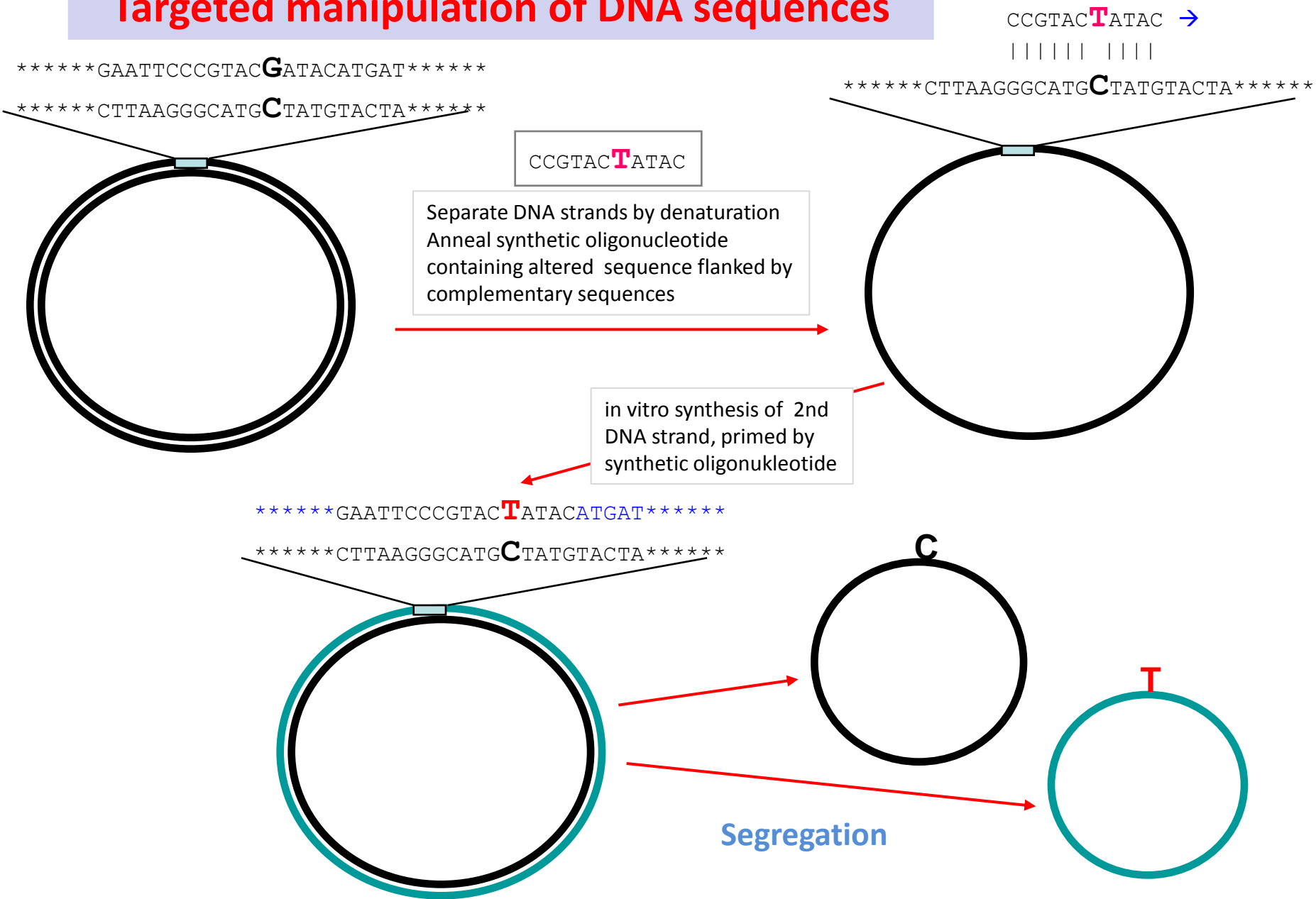
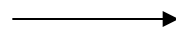

Figure 8.9 Various stages in the condensation of DNA (A) and chromatin (B through E) in forming a metaphase chromosome (F). The dimensions indicate known sizes of intermediates, but the detailed structures are hypothetical.

Targeted manipulation of DNA sequences



Autonomous Replication



Plasmids	Viruses	ARS
----------	---------	-----

Integration into genome

Site specific -- Ectopic

A Integrated

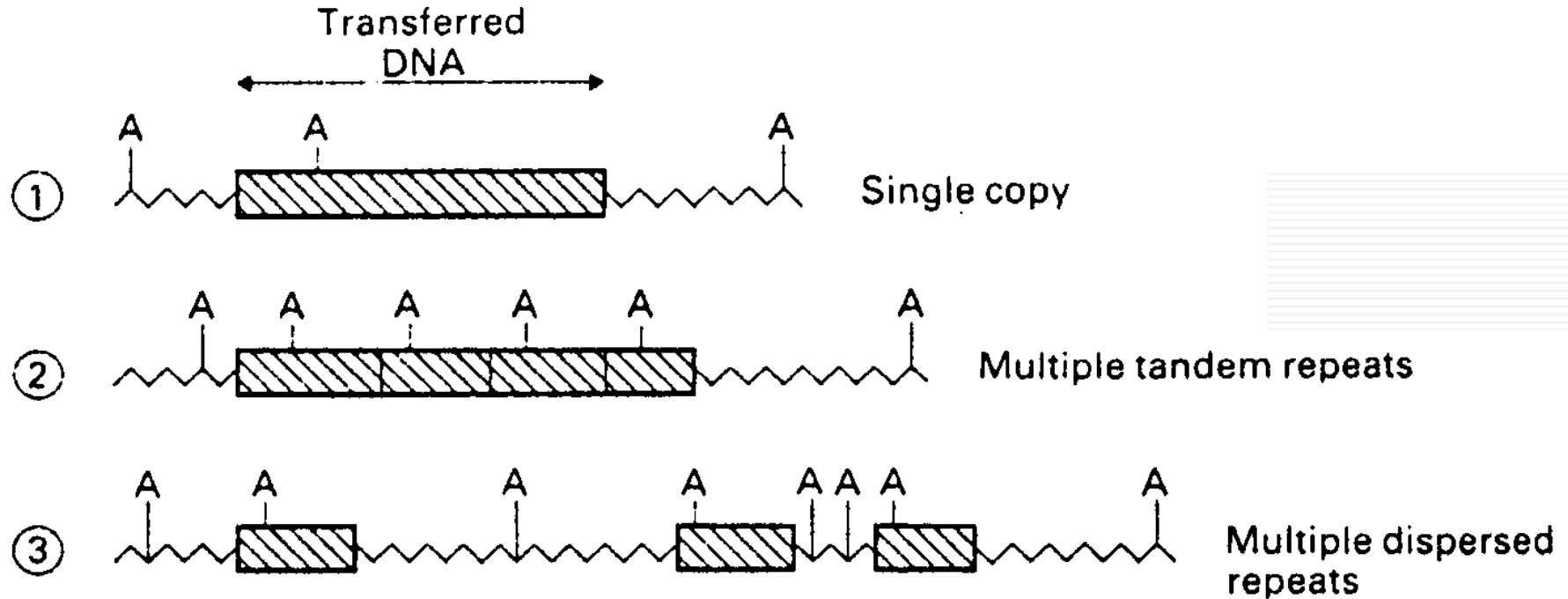

Vectors for Recombinant DNA Technology

Plasmids

Autonomous Replication
Integration into genome
Shuttle Plasmids

E.coli → Target host

Cosmids, Bacmids

Plasmid – Bacteriophage Hybrids

Phages

Bacteriophage Lambda

Artificial Chromosomes

YAC

Viruses

Baculovirus – Insect Cells
Retroviruses – Mammalian Cells

6

Gene Replacement (A)

→ Double Cross-over at regions showing sufficient homology
Linearized DNA

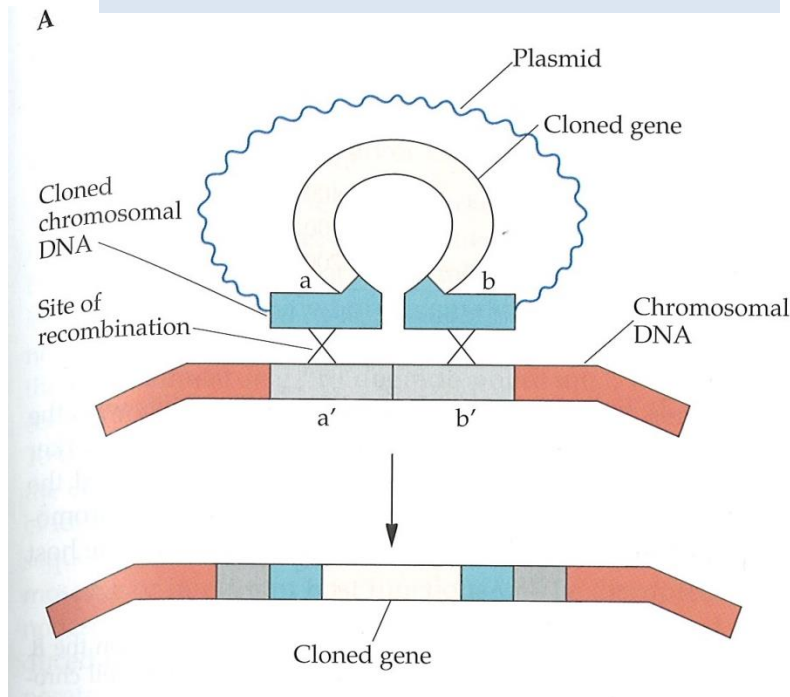

Site specific Insertion (B)

→ → Single Cross-over at regions showing sufficient homology

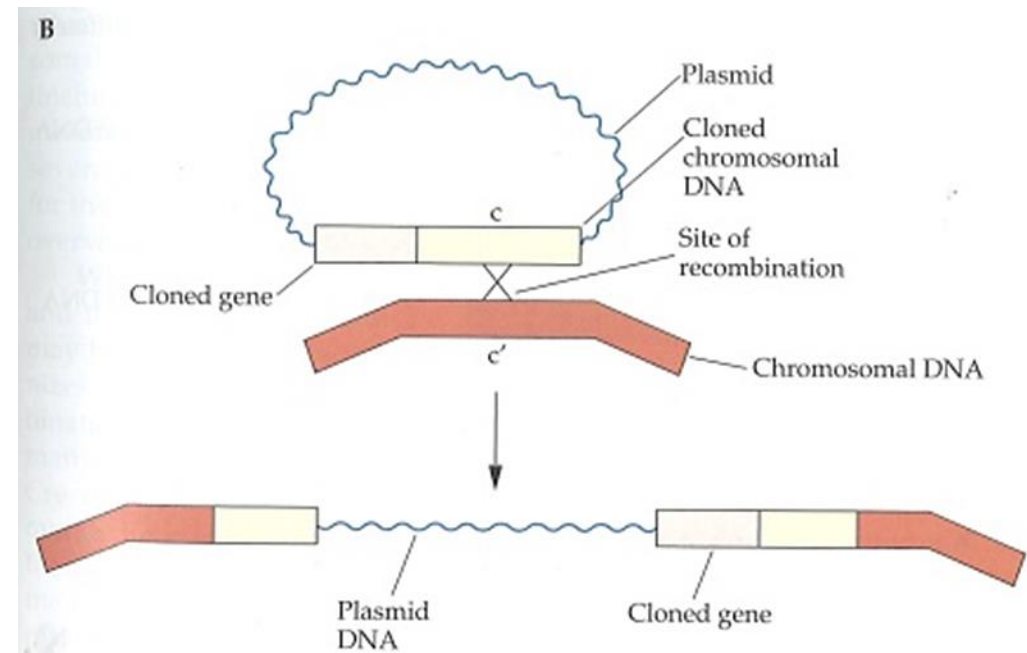

Ectopic Integration

→ Recombination at regions of no (low ?) Homology

Integration of a cloned gene into a chromosomal site. **(A)** The cloned gene has been inserted, on a plasmid, in the middle of the cloned segment of DNA (ab) from the host chromosome. Homologous DNA pairing occurs between plasmid-borne DNA regions a and b and host chromosome DNA regions a' and b', respectively. A double cross-over event (x—x) results in the integration of the cloned gene. **(B)** The cloned gene is inserted adjacent to the cloned DNA from the host chromosome (c). Homologous DNA pairing occurs between plasmid DNA region c and host chromosome DNA region c'. A single recombination event (x) within the paired c-c' DNA region results in the integration of the entire plasmid, including the cloned gene.

Plasmid vectors for bacteria

Bacterial plasmids

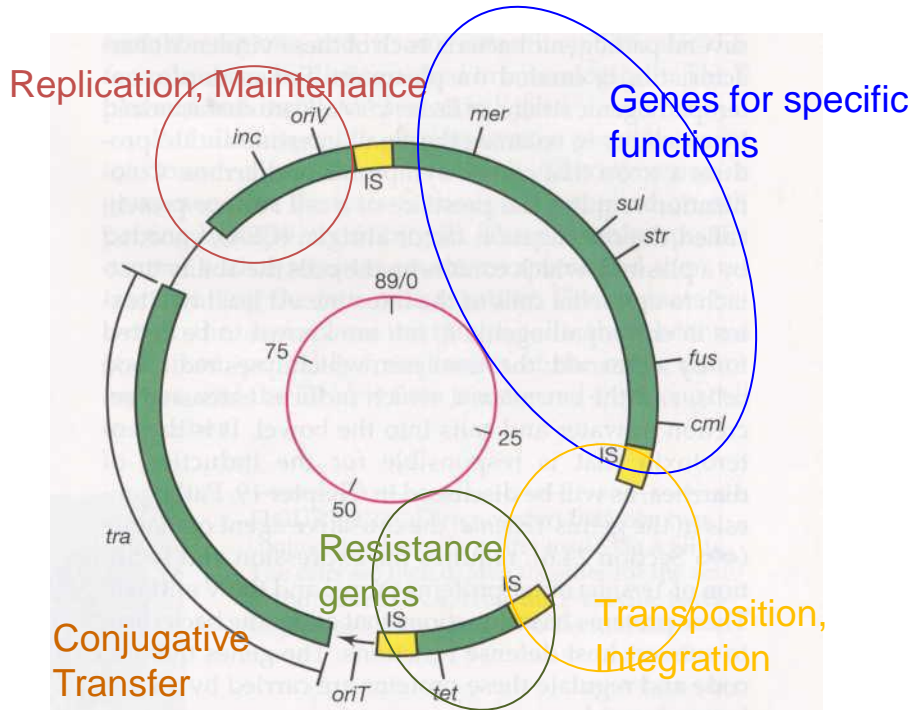

FIGURE 9.21 Genetic map of the resistance plasmid R100. The inner circle shows the size of the plasmid in kilobase pairs. The outer circle shows the location of major antibiotic resistance genes and other key functions: *inc*, incompatibility genes; *oriV*, origin of replication site; *oriT*, origin of conjugative transfer; *mer*, mercuric ion resistance; *sul*, sulfonamide resistance; *tet*, tetracycline resistance; *tra*, transfer functions. The locations of insertion sequences (IS) are also shown.

Replication

- Origin of replication (*oriV*)
- Regulatory functions for replication (*rep*, *trf*)
- copy number
- Host range
- incompatibility

Maintenance

- Partitioning systems (*par*)
- Multimer resolution systems (*mrs*)
- Addiction systems (e.g. *hok-sok*)
- Stable maintenance of plasmids upon cell division

Conjugative transfer

- Complete Transfer regions (*tra*)
- Mobilization regions (*mob*, *oriT*, *nic*, *bom*)
- Autonomous In vivo transfer of plasmids
- In vivo transfer mediated by helper functions

Plasmid vector

(A) pBluescript plasmid (2961 bp)

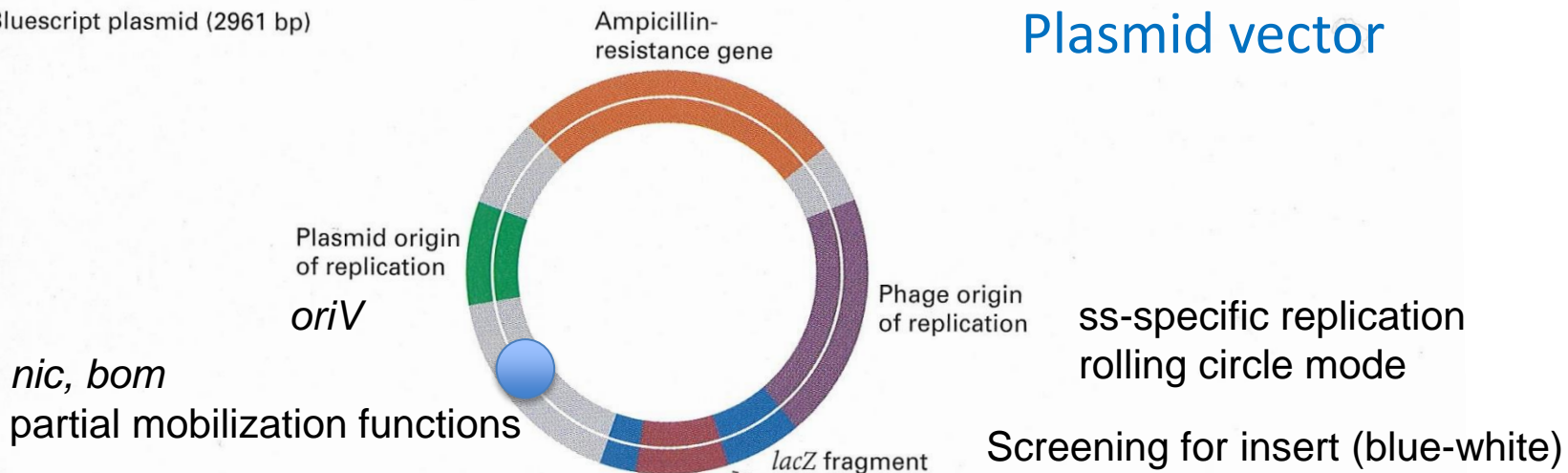

ss-specific replication rolling circle mode

Screening for insert (blue-white)

(B)

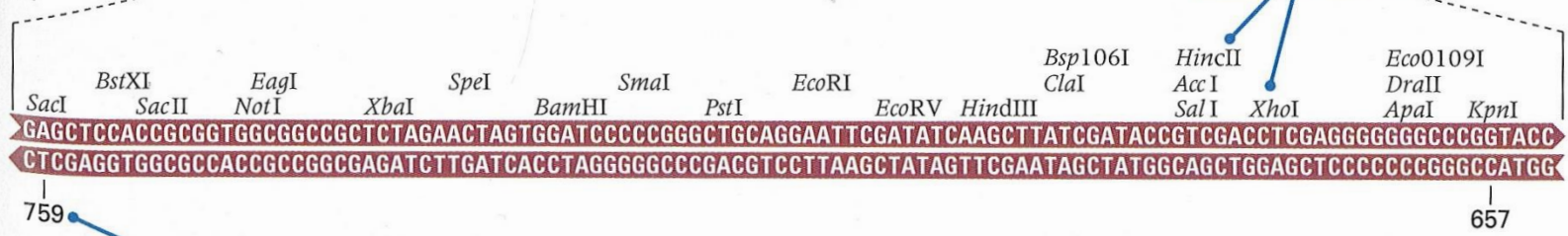

Polylinker comprises nucleotides numbered 759 through 657 in plasmid DNA sequence

Figure 12.9 (A) Diagram of the cloning vector pBluescript II. It contains a plasmid origin of replication, an ampicillin-resistance gene, a multiple cloning site (polylinker) within a fragment of the *lacZ* gene from *E. coli*, and a bacteriophage origin of replication. (B) Sequence of the multiple cloning site showing the unique restriction sites at which the vector can be opened for the insertion of DNA fragments. The numbers 657 and 759 refer to the position of the base pairs in the complete sequence of pBluescript. [Courtesy of Stratagene Cloning Systems, La Jolla, CA.]

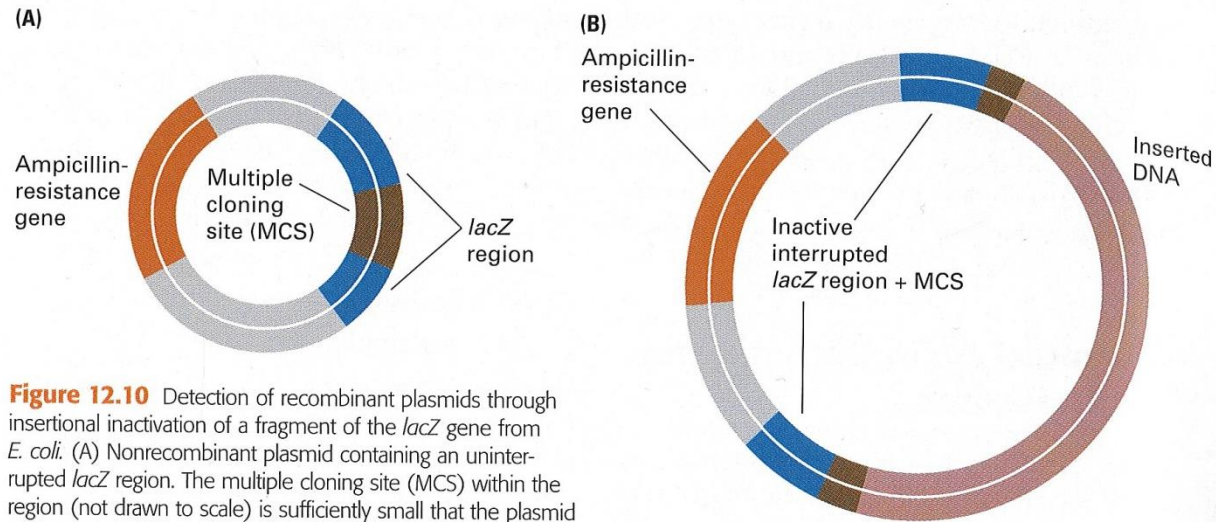
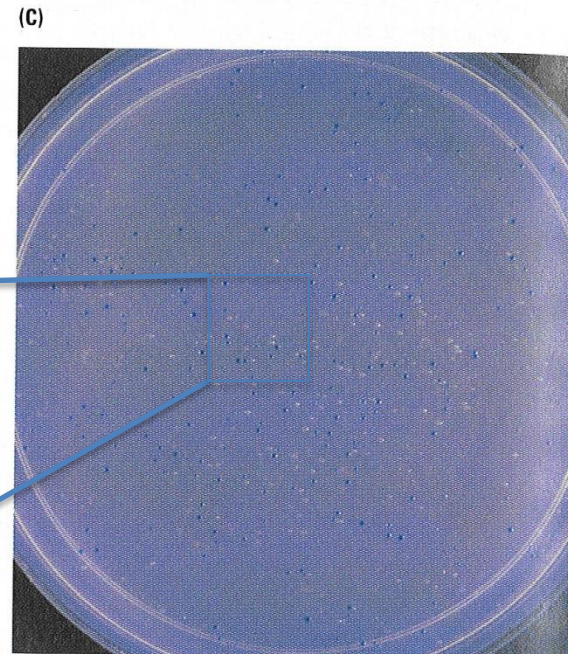

Figure 12.10 Detection of recombinant plasmids through insertional inactivation of a fragment of the *lacZ* gene from *E. coli*. (A) Nonrecombinant plasmid containing an uninserted *lacZ* region. The multiple cloning site (MCS) within the region (not drawn to scale) is sufficiently small that the plasmid still confers β -galactosidase activity. (B) Recombinant plasmid with donor DNA inserted into the multiple cloning site. This plasmid confers ampicillin resistance but not β -galactosidase activity, because the donor DNA interrupting the *lacZ* region is large enough to render the region nonfunctional. (C) Transformed bacterial colonies. Cells in the white colonies contain plasmids with inserts that disrupt the *lacZ* region; those in the blue colonies do not. [C courtesy of Elena R. Lozovsky.]



Bacteriophage Lambda Vectors

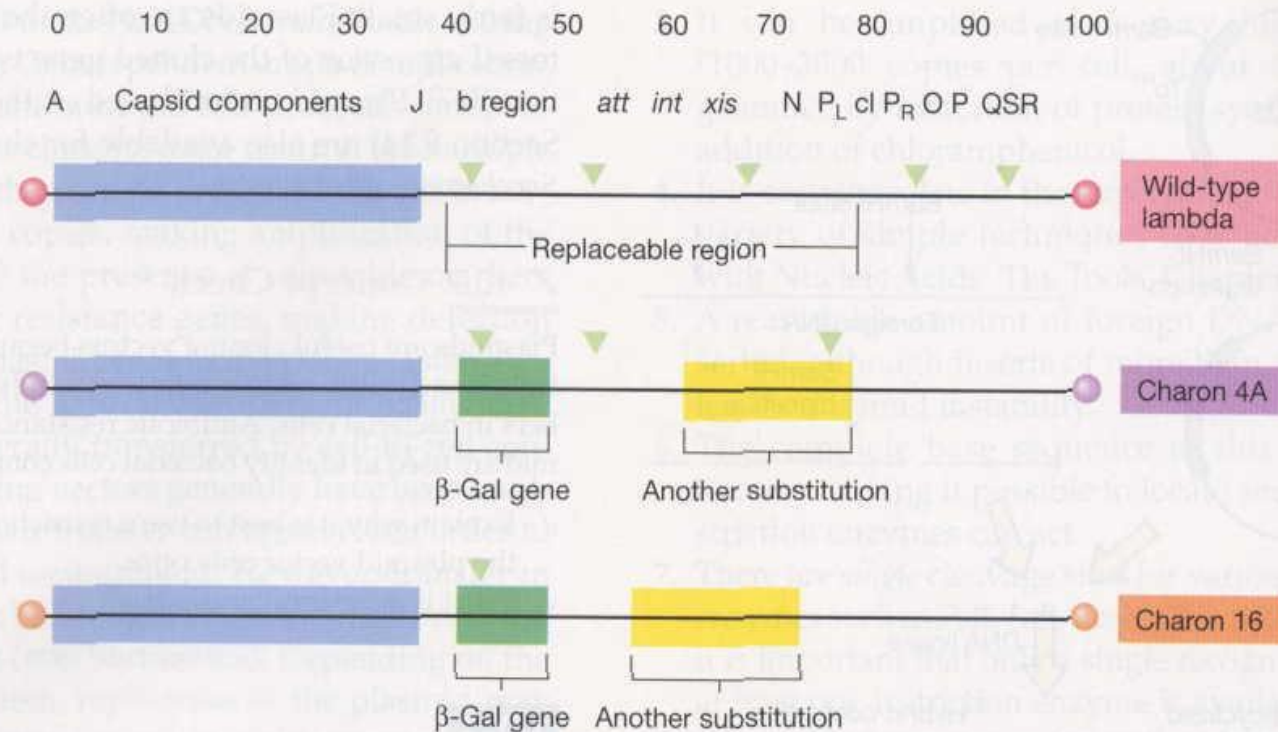



FIGURE 10.3 Molecular cloning with lambda. Abbreviated genetic map of bacteriophage lambda showing the cohesive ends as circles ( Figure 8.26). Charon 4A and 16 are both derivatives of lambda, which have various substitutions and deletions in the nonessential region. One of the substitutions in each case is a gene (β -Gal) that codes for the enzyme β -galactosidase, which permits detection of clones containing this phage. Whereas the wild-type lambda genome is 48.5 kilobase pairs, that for Charon 4A is 45.4 and that for Charon 16 is 41.7 kilobase pairs. The arrows (\blacktriangledown) shown above the maps of each phage indicate the sites recognized by the restriction enzyme *EcoRI*.

Bacteriophage Lambda Vectors

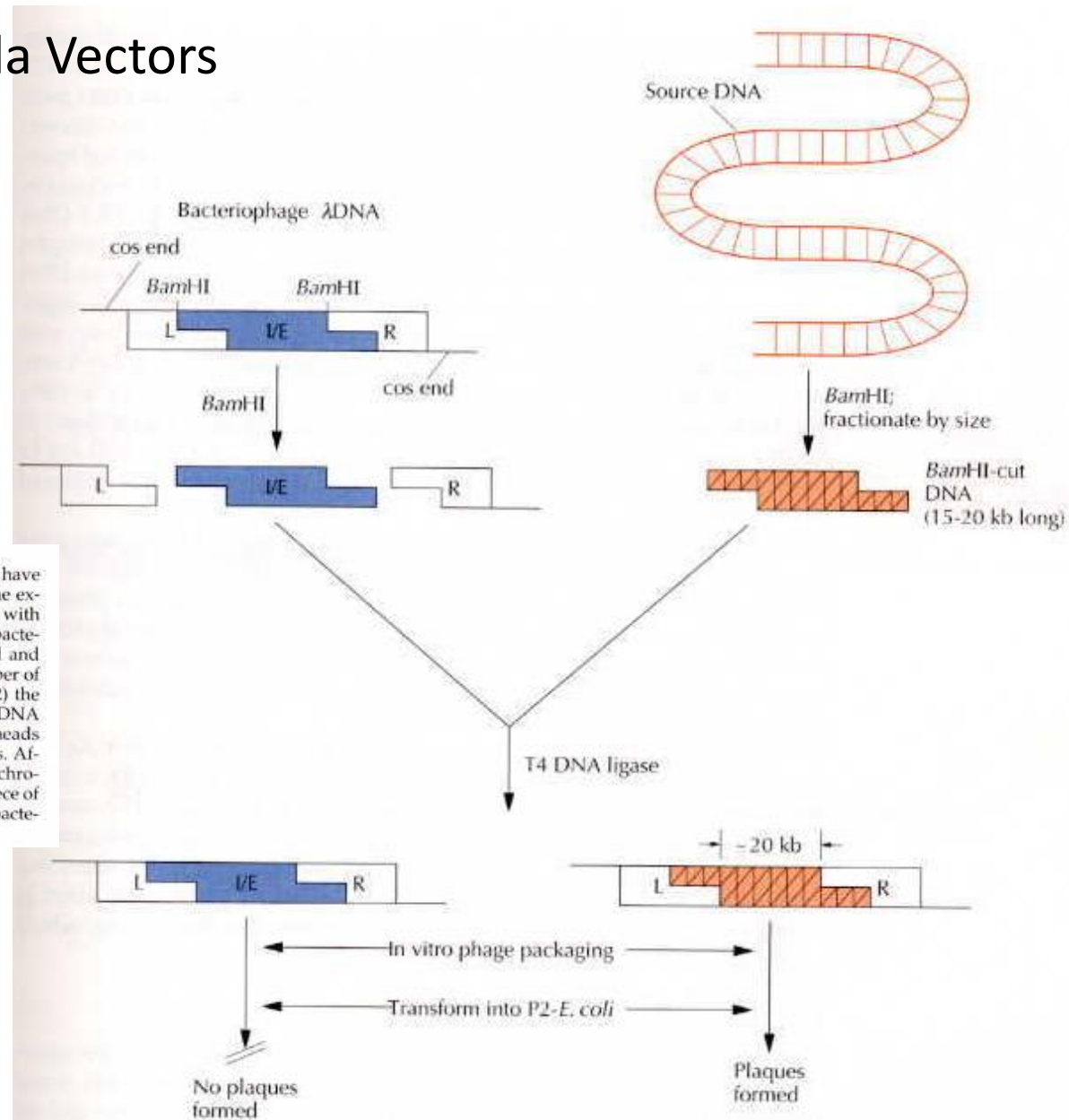

Figure 4.17 Bacteriophage λ cloning system. Bacteriophage λ is engineered to have two *Bam*HI sites that flank the *I/E* region of the bacteriophage λ genome. The extensions indicate the *cos* ends of the λ DNA. For cloning, the source DNA is cut with *Bam*HI and fractionated by size to isolate pieces that are 15 to 20 kb long. The bacteriophage λ DNA is also cut with *Bam*HI. The two DNA samples are mixed and treated with T4 DNA ligase. The ligation reaction mixture will contain a number of different DNA molecules, including (1) reconstituted bacteriophage λ and (2) the bacteriophage λ *L* and *R* regions with a 20-kb piece of DNA from the source DNA instead of the *I/E* region. These molecules are packaged into bacteriophage λ heads *in vitro*, and infective particles are formed after the addition of tail assemblies. After infection of *E. coli* cells that have P2 bacteriophage DNA integrated in their chromosomes, only the molecules with the *R* and *L* regions and a cloned ~20-kb piece of DNA can replicate and form infectious bacteriophage λ . In this way, only the bacteriophage λ containing a DNA insert are perpetuated.

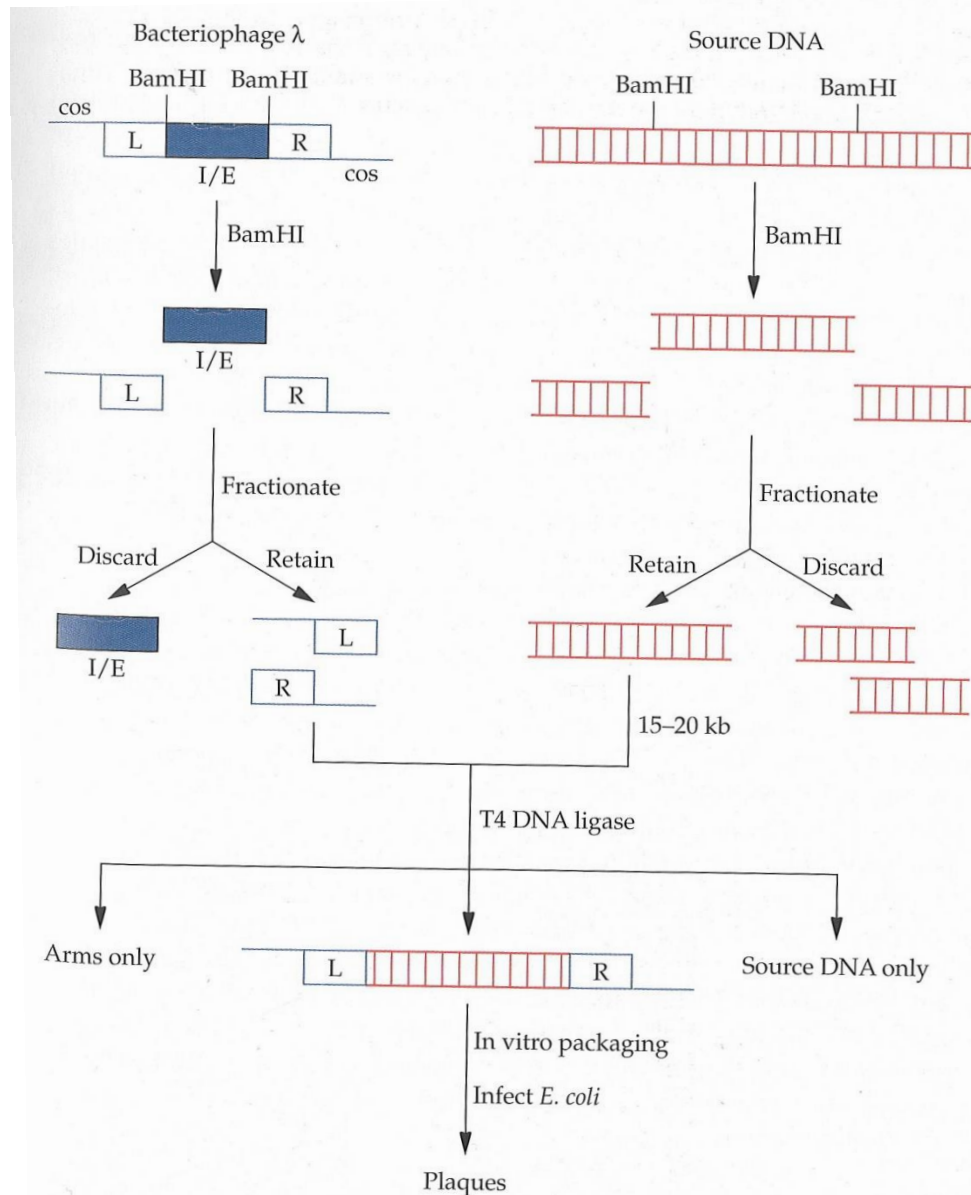

FIGURE 3.31 A bacteriophage λ cloning system. Bacteriophage λ is engineered to have two BamHI sites that flank the I/E region. For cloning, the source DNA is cut with BamHI and fractionated by size to isolate pieces that are about 15 to 20 kb long. The bacteriophage λ DNA is also cut with BamHI, and size fractionation removes the I/E segment. The L and R arms, plus the 15- to 20-kb source DNA molecules, are mixed with T4 DNA ligase. The ligation reaction produces a number of different DNA molecules, including ligated source DNA only, combined L and R arms only, and molecules that have a source DNA molecule flanked by L and R arms. The last molecules are packaged into bacteriophage heads in vitro, and infective particles are formed after the addition of tail assemblies. The recombined bacteriophage λ is perpetuated by infection of *E. coli*. Some 50-kb source DNA ligation products may be packaged into heads, but since this DNA lacks both a functional origin of replication and cos ends, it cannot be perpetuated. Other ligation products are either too small or too large to be packaged. For some bacteriophage λ cloning systems (not shown here), high packaging efficiency is achieved by setting the conditions of ligation to favor concatemer formation to imitate how the phage heads are normally filled.

Cloning in Lambda Vectors

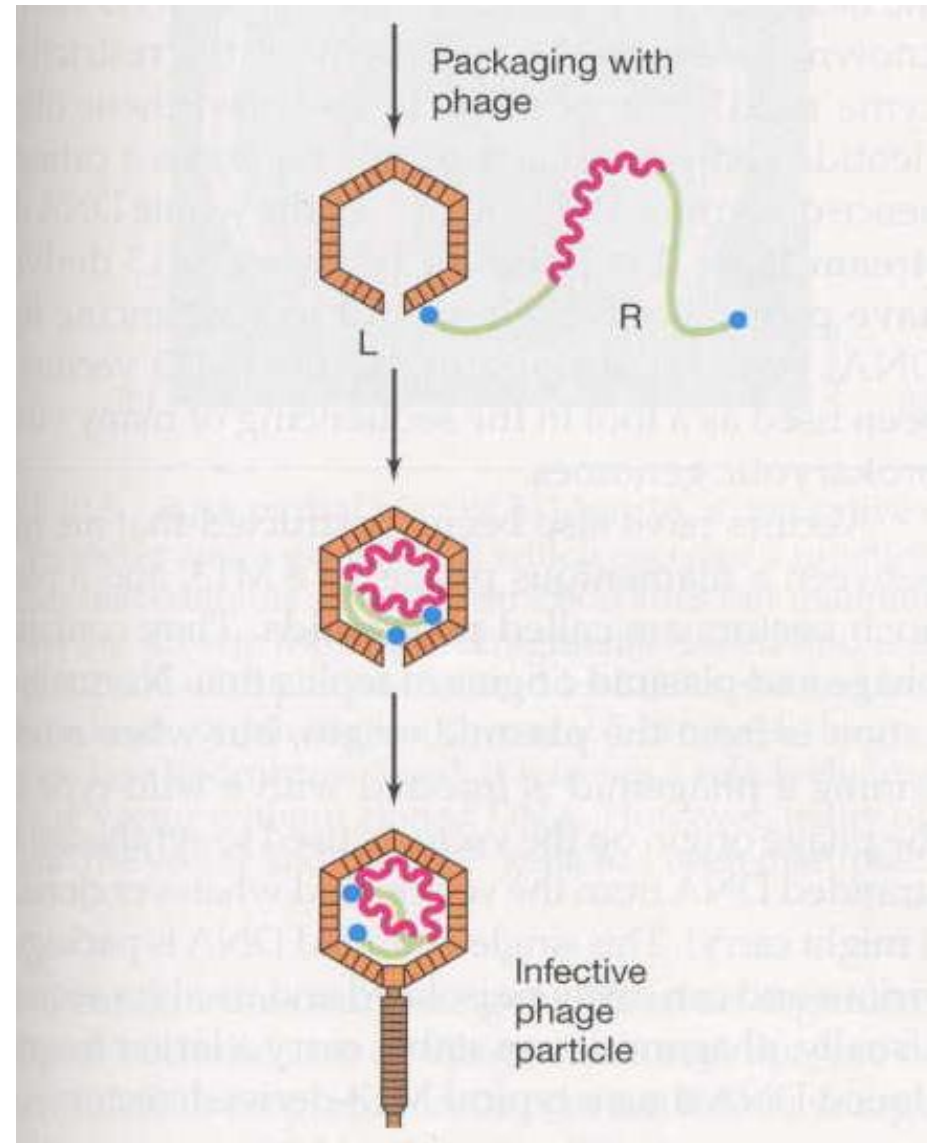
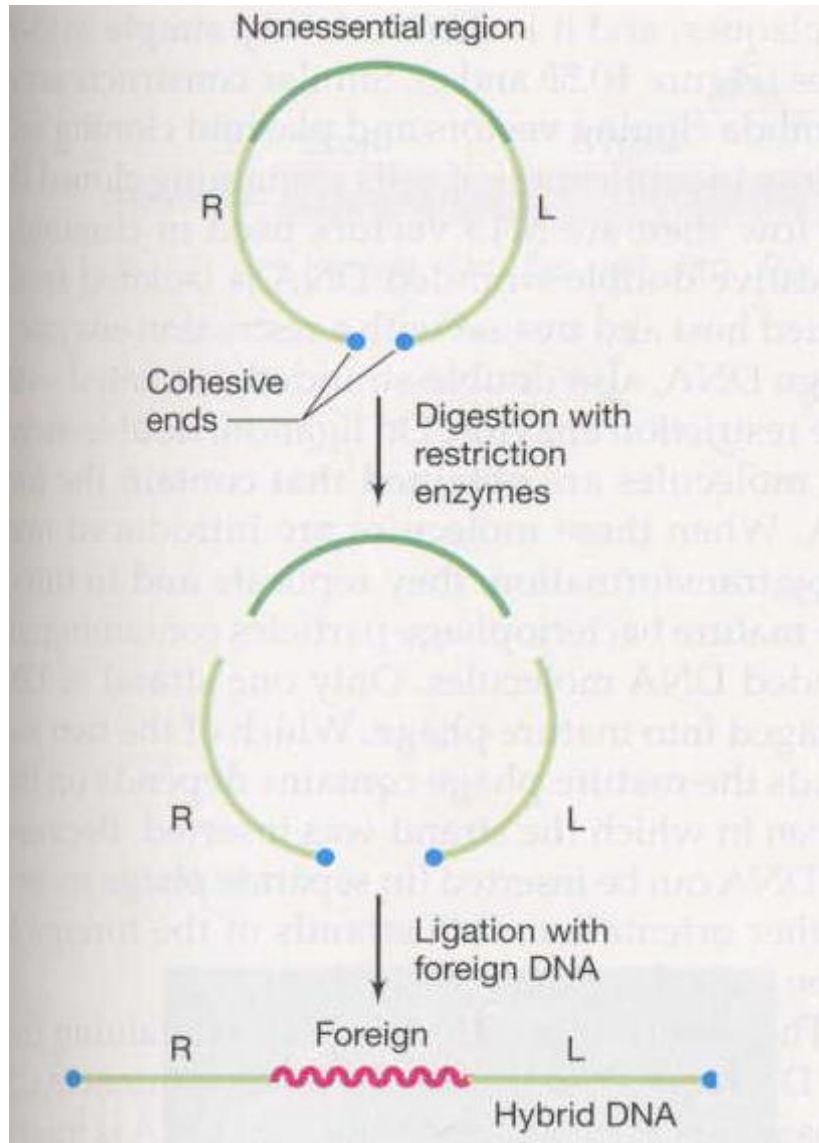
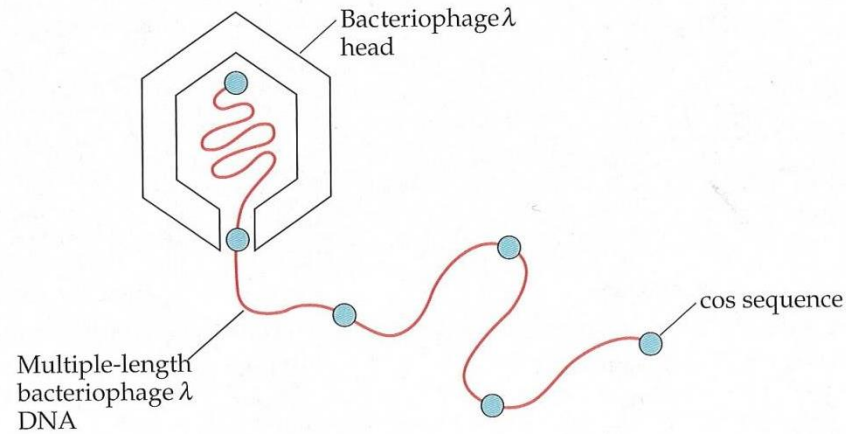
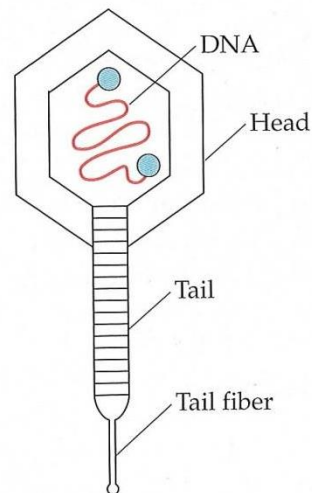

FIGURE 3.30 Packaging of bacteriophage λ DNA into heads during the lytic cycle. **(A)** DNA replication from the circular form of bacteriophage λ creates a linear form that has contiguous, multiple lengths (concatemers) of bacteriophage DNA with units of approximately 50 kb each. **(B)** Each newly assembled head is filled with a 50-kb unit of λ DNA before the tail assembly is attached.

A



B



Cosmid vectors

Principle: Plasmid DNA
Transfer via Phage infection

Resulting recombinant clone
Contains self-replicating
plasmid

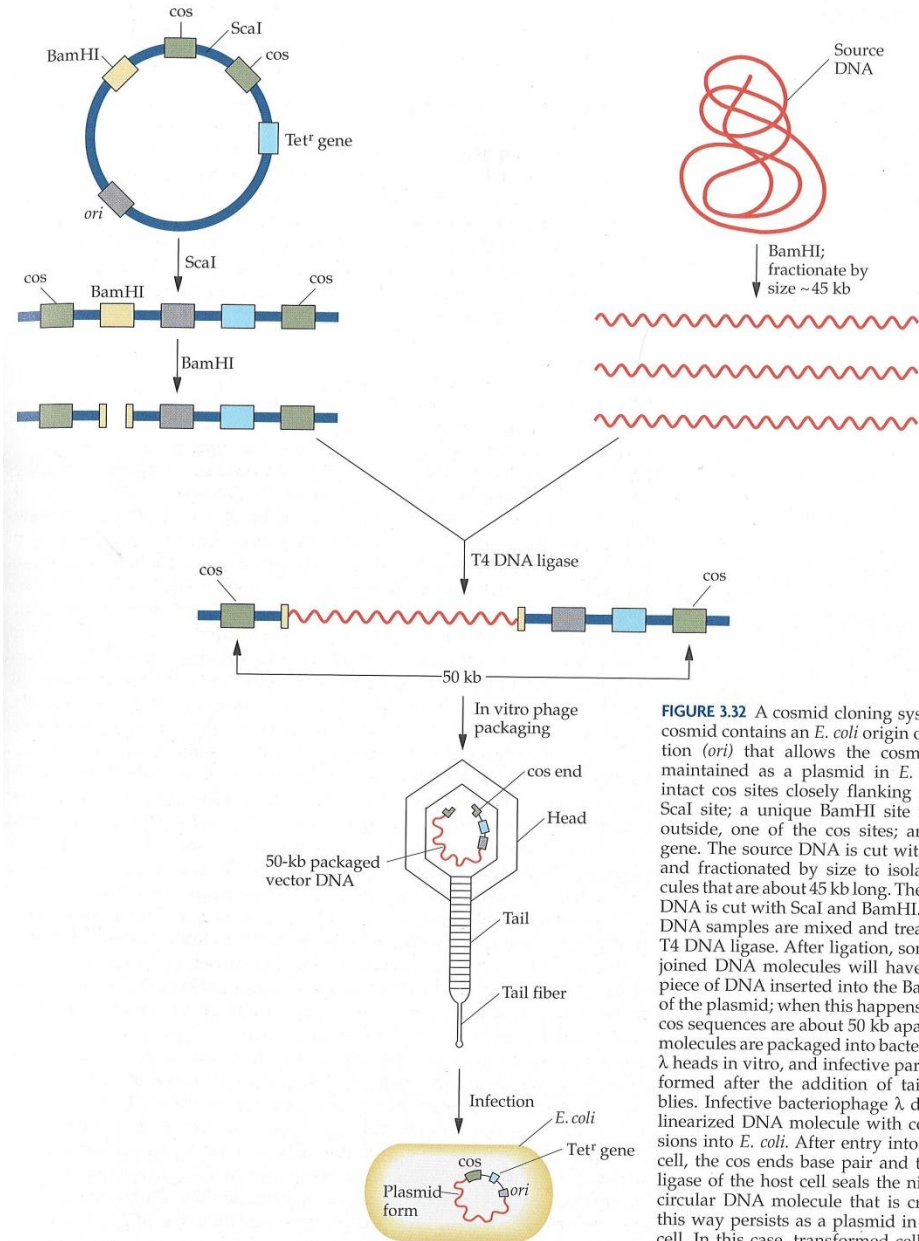
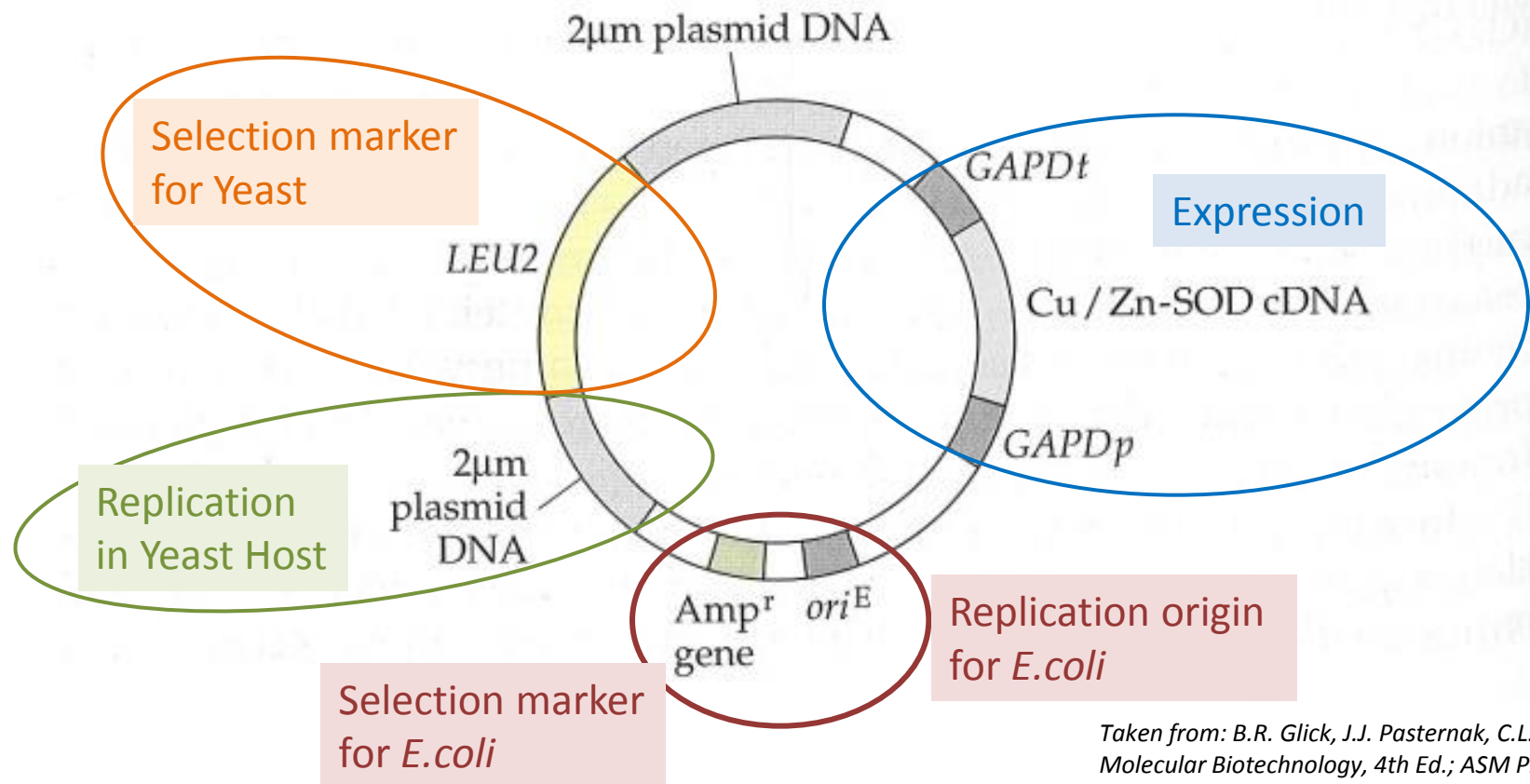

FIGURE 3.32 A cosmid cloning system. The cosmid contains an *E. coli* origin of replication (*ori*) that allows the cosmid to be maintained as a plasmid in *E. coli*; two intact *cos* sites closely flanking a unique *ScaI* site; a unique *BamHI* site near, but outside, one of the *cos* sites; and a *Tet^r gene*. The source DNA is cut with *BamHI* and fractionated by size to isolate molecules that are about 45 kb long. The plasmid DNA is cut with *ScaI* and *BamHI*. The two DNA samples are mixed and treated with T4 DNA ligase. After ligation, some of the joined DNA molecules will have a 45-kb piece of DNA inserted into the *BamHI* site of the plasmid; when this happens, the two *cos* sequences are about 50 kb apart. These molecules are packaged into bacteriophage λ heads in vitro, and infective particles are formed after the addition of tail assemblies. Infective bacteriophage λ delivers a linearized DNA molecule with *cos* extensions into *E. coli*. After entry into the host cell, the *cos* ends base pair and the DNA ligase of the host cell seals the nicks. The circular DNA molecule that is created in this way persists as a plasmid in the host cell. In this case, transformed cells can be identified because they are resistant to the antibiotic tetracycline.

FIGURE 7.7 *S. cerevisiae* expression vector. The cDNA for human Cu/Zn-SOD was cloned between the promoter (*GAPDp*) and termination–polyadenylation sequence (*GAPDt*) of the *S. cerevisiae* glyceraldehyde phosphate dehydrogenase gene. The *LEU2* gene that was cloned between segments of the yeast 2 μ m plasmid DNA encodes a functional enzyme of the leucine biosynthesis pathway. The yeast origin of replication is included in the 2 μ m plasmid DNA. The ampicillin resistance (*Amp^r*) gene and the *E. coli* origin of replication (*ori^E*) are derived from plasmid pBR322.



13.10.16

Expression Cassette

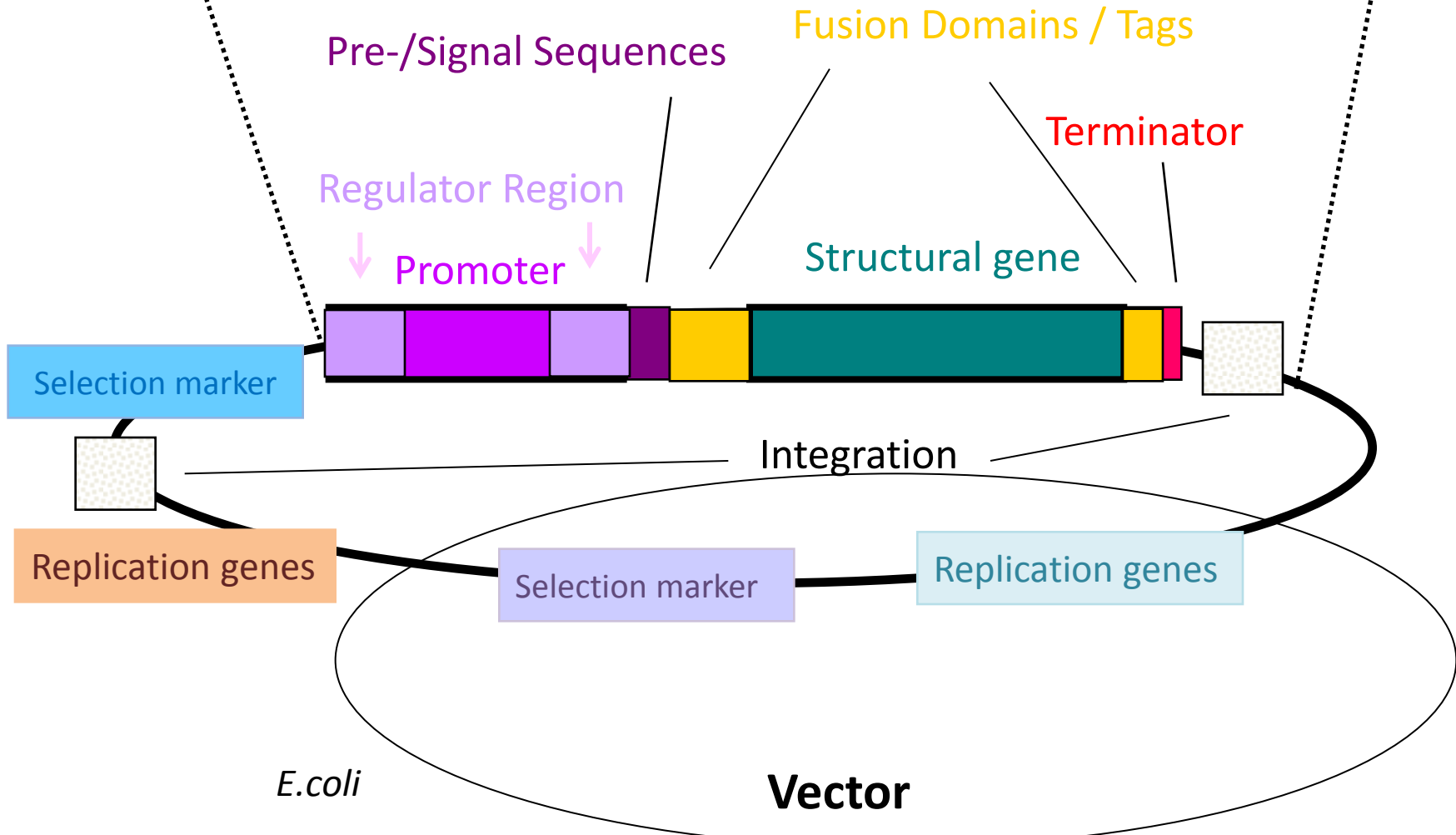

Gene Expression in Prokaryotes

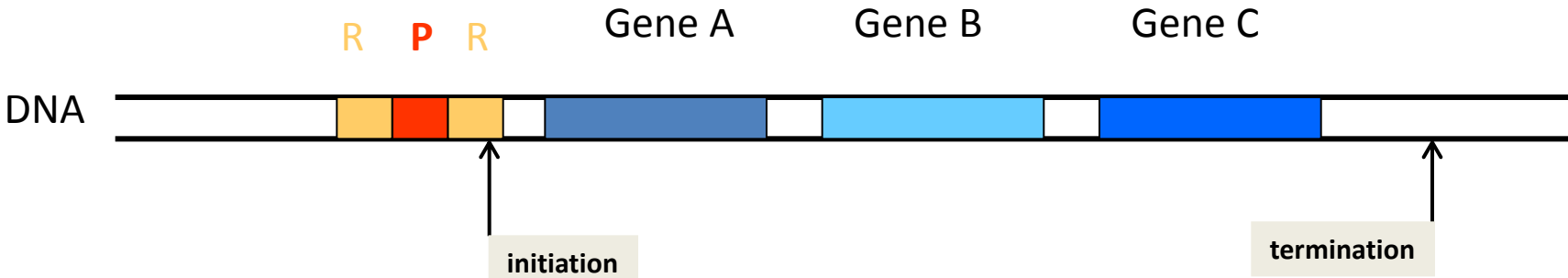

Transcription

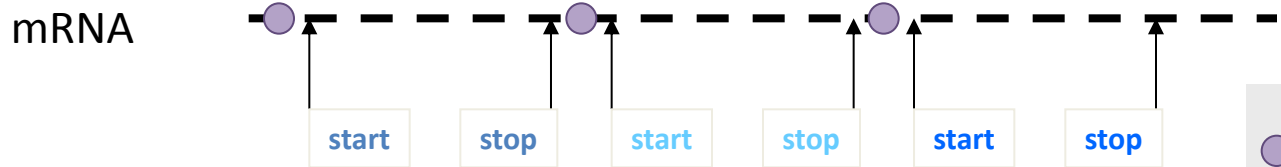

Translation



Protein

-  Ribosome Binding Site (Shine Dalgarno)
-  Promoter
-  Regulatory Region (e.g. Operator)

Post-translational processing

Location in Genome → Autonomous replication, Integration

Transcription Initiation → Promoters **Transcription Termination**

Regulatory Systems → positive/negative regulatory systems

Transcript Processing

RNA Structure

mRNA stability

Translation Initiation - Translation elongation

Codon usage

Post-translational modifications

Modification of AA-side chains: Glycosylation, Phosphorylation, etc

Proteolytic Processing

Protein Folding

Disulfide bond formation

Assembly of subunits

Toxicity of gene products

Protein degradation

Localization

Intracellular

Periplasmic

Extracellular

Membrane associated

Organelle specific

Surface display

Heterologous expression in prokaryotes – *E.coli*

Transcription

constitutive promoters

regulated promoters

lambda p_L , p_R

lac, *trp*, *tac*. *Trc*, *ara*

T7, T5, T3

termination

rrnB (T1,T2), *trpt*

Lambda N gene (premature termination)

m-RNA stability

Translation

Initiation – SD sequence ...AGGAG....

elongation – codon usage

Proteolysis

Lon, Clp, *htpR* (heat shock regulatory protein)

Plasmid copy number and segregation

Regulated Promoters \leftrightarrow Constitutive Promoters

Both systems are used

Preferred Combination: strong Promoters – tightly regulated

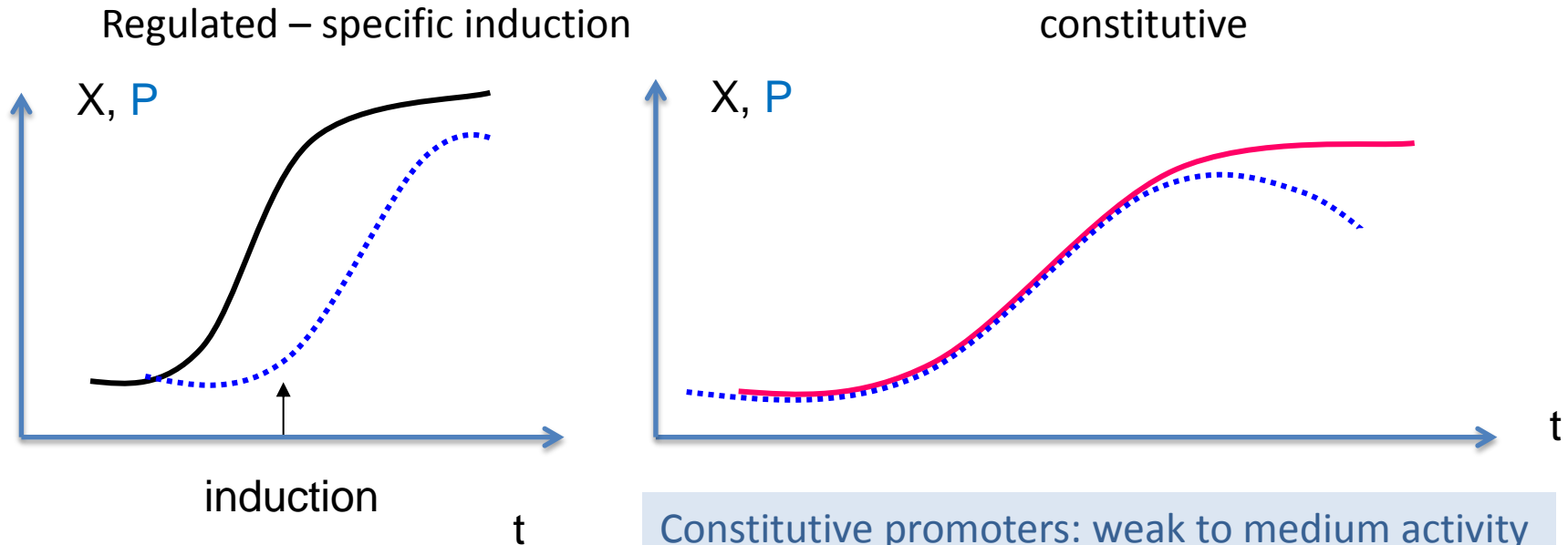

Constitutive promoters: weak to medium activity

Regulated expression:
 Separation of growth phase
 and production phase
 → High specific growth rate
 in growth phase

Constitutive Expression: growth is impaired
 due to heavy metabolic load directed to
 expression of one specific protein
 → Overall low specific growth rate
 → Lower overall productivity

FIGURE 2.25 Induction of the off state for transcription of a bacterial operon. The binding of a corepressor molecule (C) to an inactive repressor protein (IR) changes the conformation of the repressor protein. The corepressor–repressor protein complex (IR-C) binds to the operator region and blocks transcription of the operon by RNA polymerase.

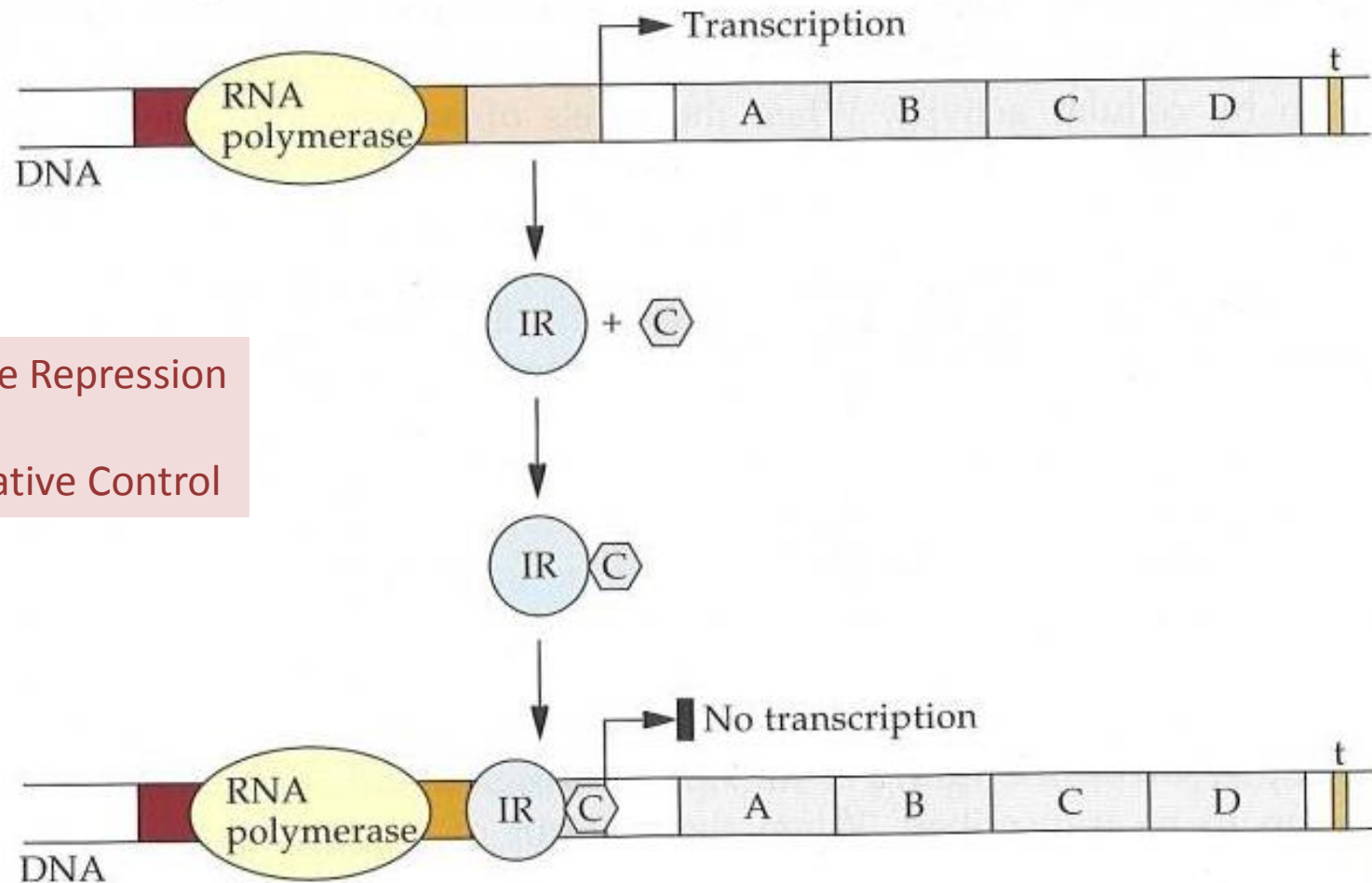

Gene Repression

negative Control

FIGURE 2.26 Activation and deactivation of a bacterial operon. An activator protein (Act) binds to an activating site and enhances the rate of transcription of the operon. When an effector molecule (E) binds to the activator protein, the Act-E complex does not bind to the activating site. The rate of transcription of the operon is diminished when the activating site is not occupied by the activating protein.

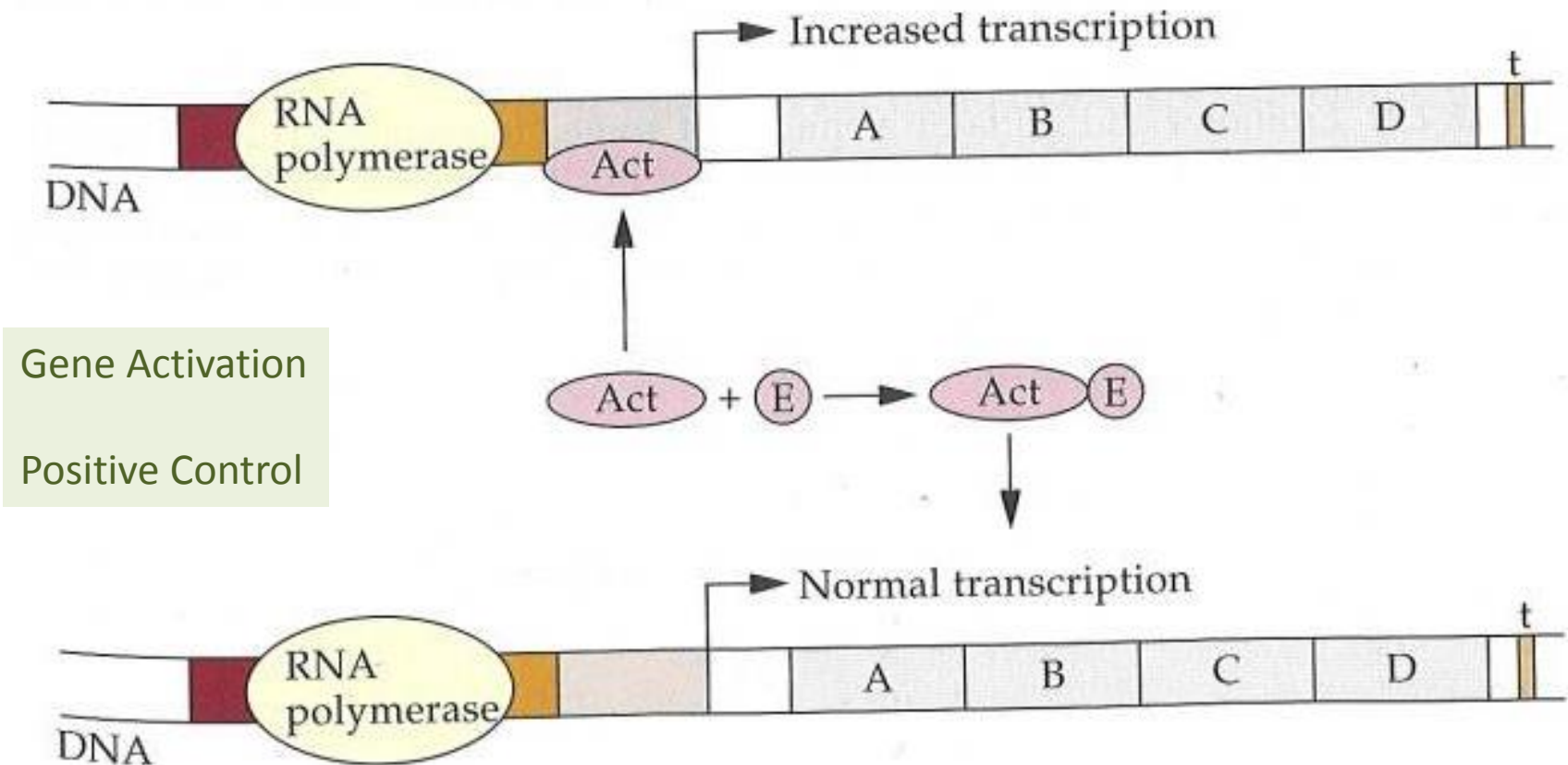

Complex Initiation System

Multiple regulation elements in concerted action

Enhancers

Activators

Repressing Systems

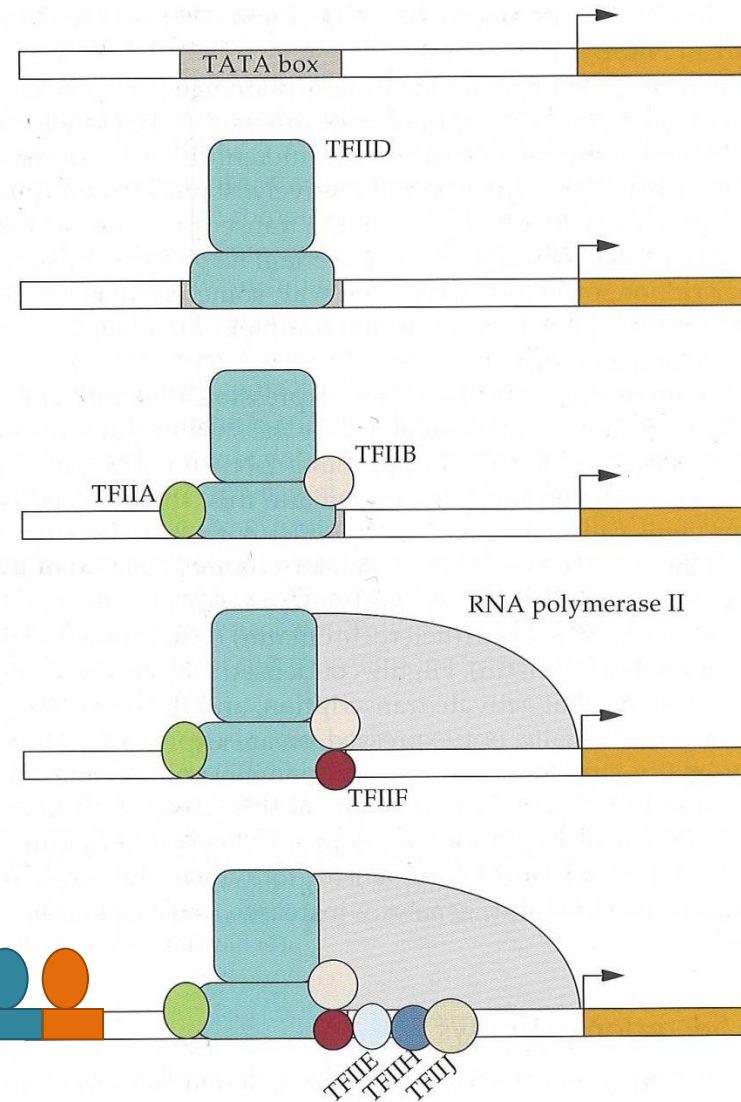
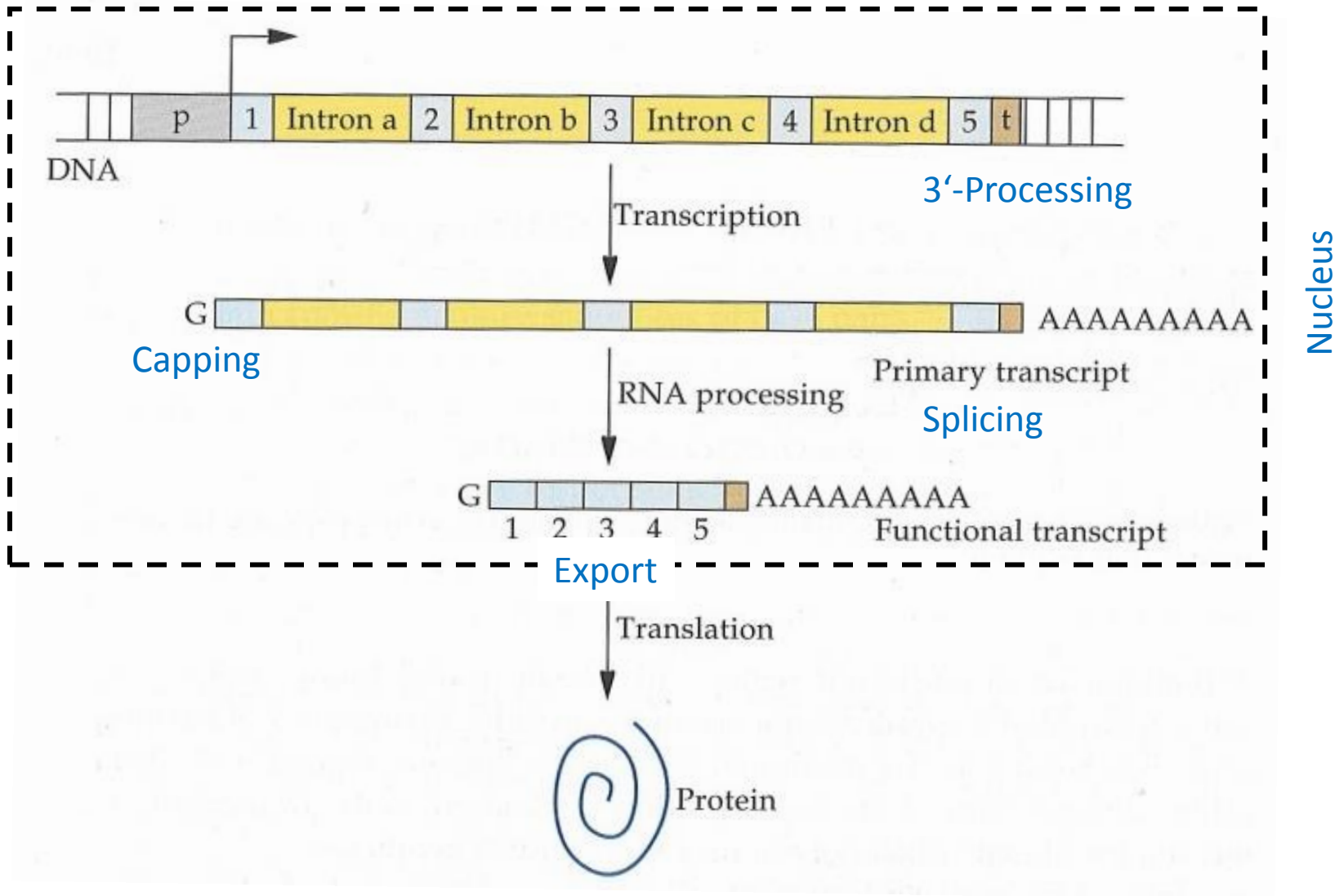

FIGURE 2.28 Formation of an RNA polymerase II transcription initiation complex at a TATA box. Transcription factor TFIID binds to a TATA box, and in sequence, other transcription factors and RNA polymerase II bind to form a protein aggregate that is responsible for initiating transcription. The right-angled arrow indicates the site of initiation and the direction of transcription.

RNA Processing → Complex Mechanisms



Alternative Splicing

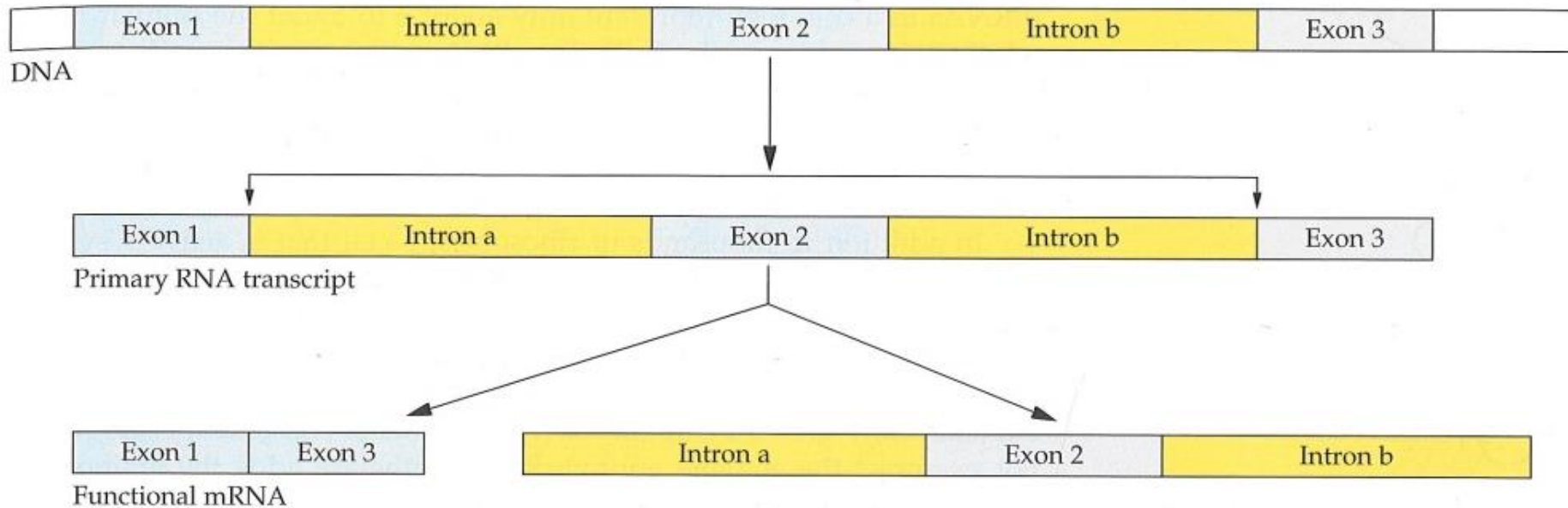

FIGURE 2.13 Alternative splicing of a eukaryotic primary RNA transcript. The bracketing arrows mark the sites that are spliced together after the removal of the intervening RNA region. In this example, exon 2, flanked by introns a and b, is spliced out of the primary transcript, and exons 1 and 3 are spliced together to form a functional mRNA transcript.

Expression Systems for E.coli

Inducible Promoters based on *lacI/lacO* repressor/operator

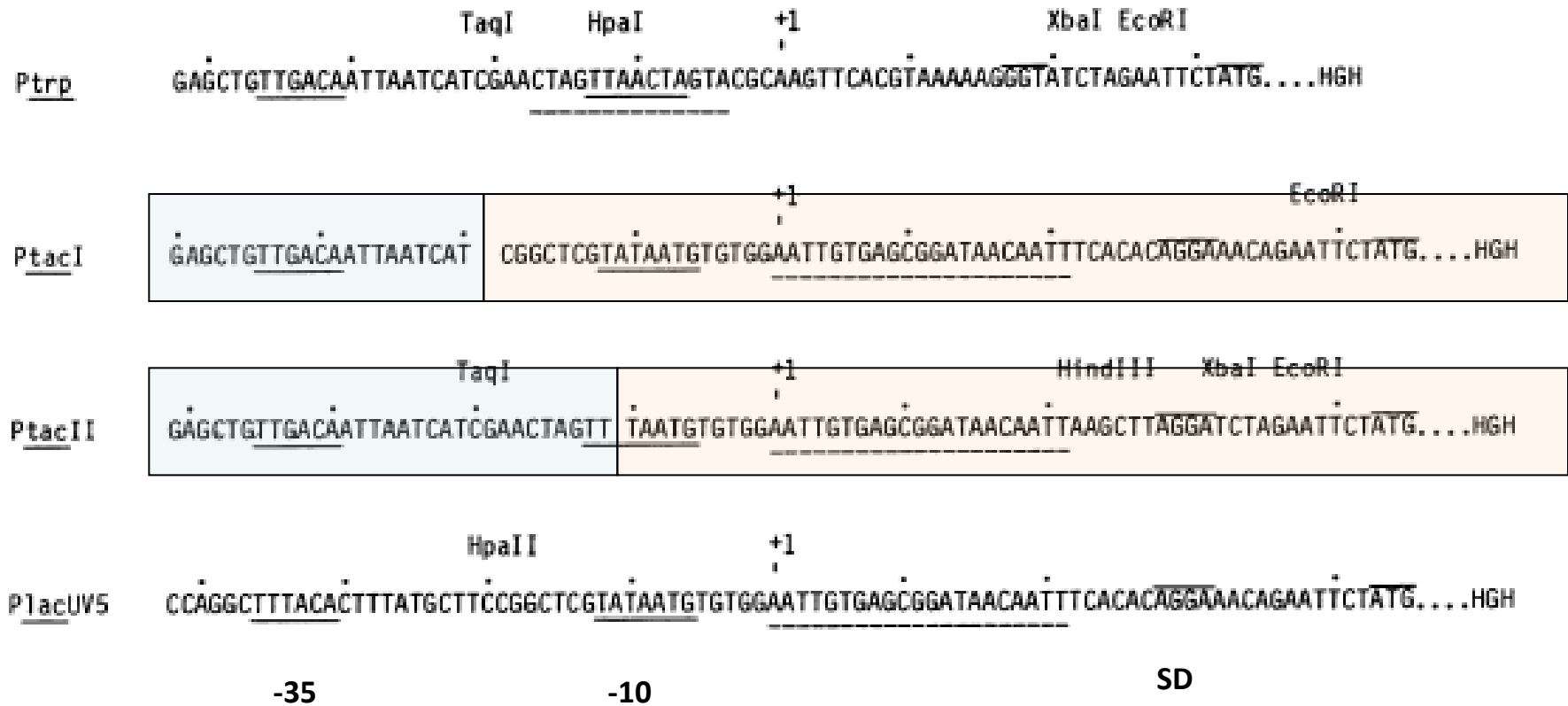
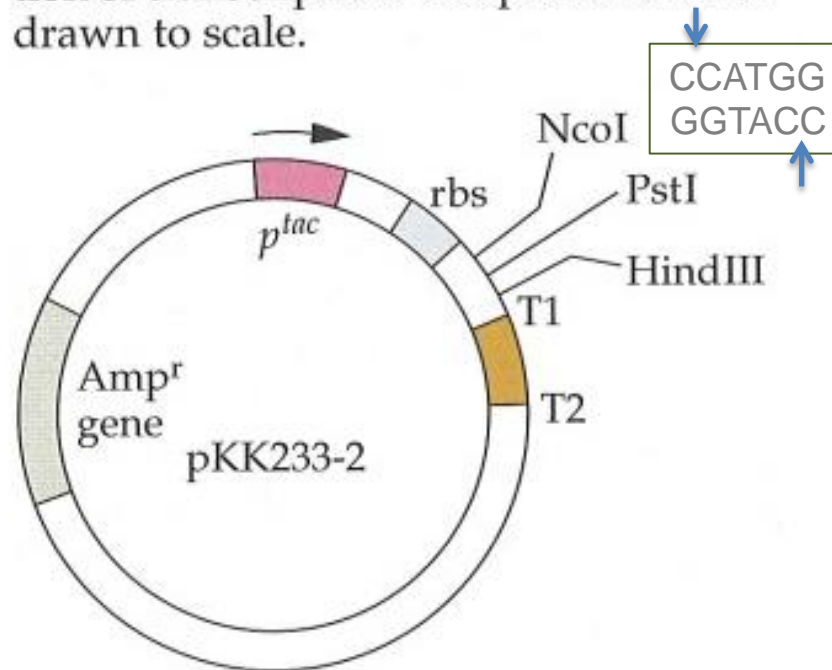
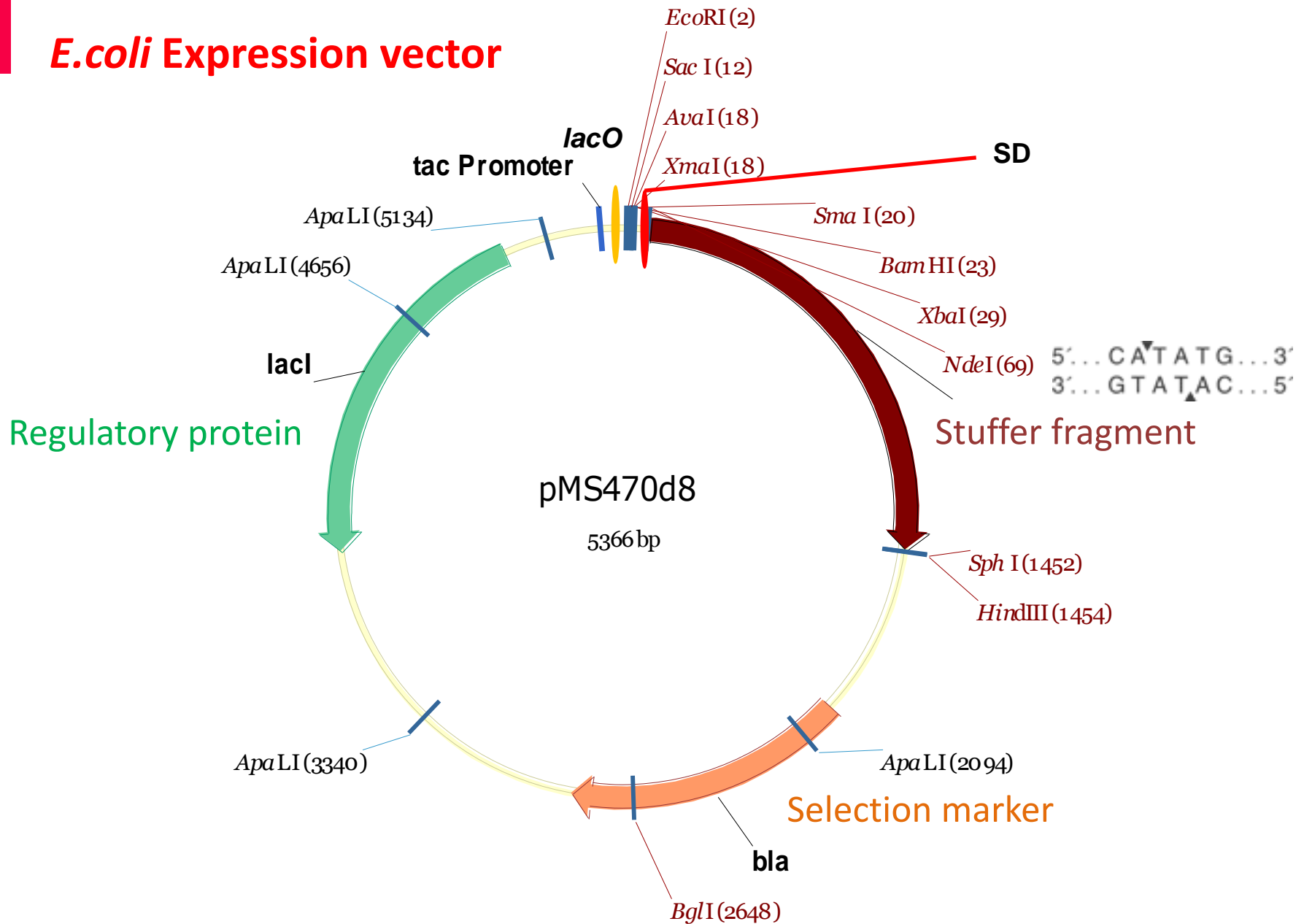

FIGURE 6.19 The expression vector pKK233-2. The plasmid pKK233-2 codes for the ampicillin resistance (Amp^r) gene as a selectable marker gene, the *tac* promoter (p^{tac}), the *lacZ* ribosome-binding site (rbs), three restriction endonuclease cloning sites (NcoI, PstI, and HindIII), and two transcription termination sequences (T1 and T2). The arrow indicates the direction of transcription. The plasmid is not drawn to scale.



14.10.16

E. coli Expression vector



pET-Expression system

32

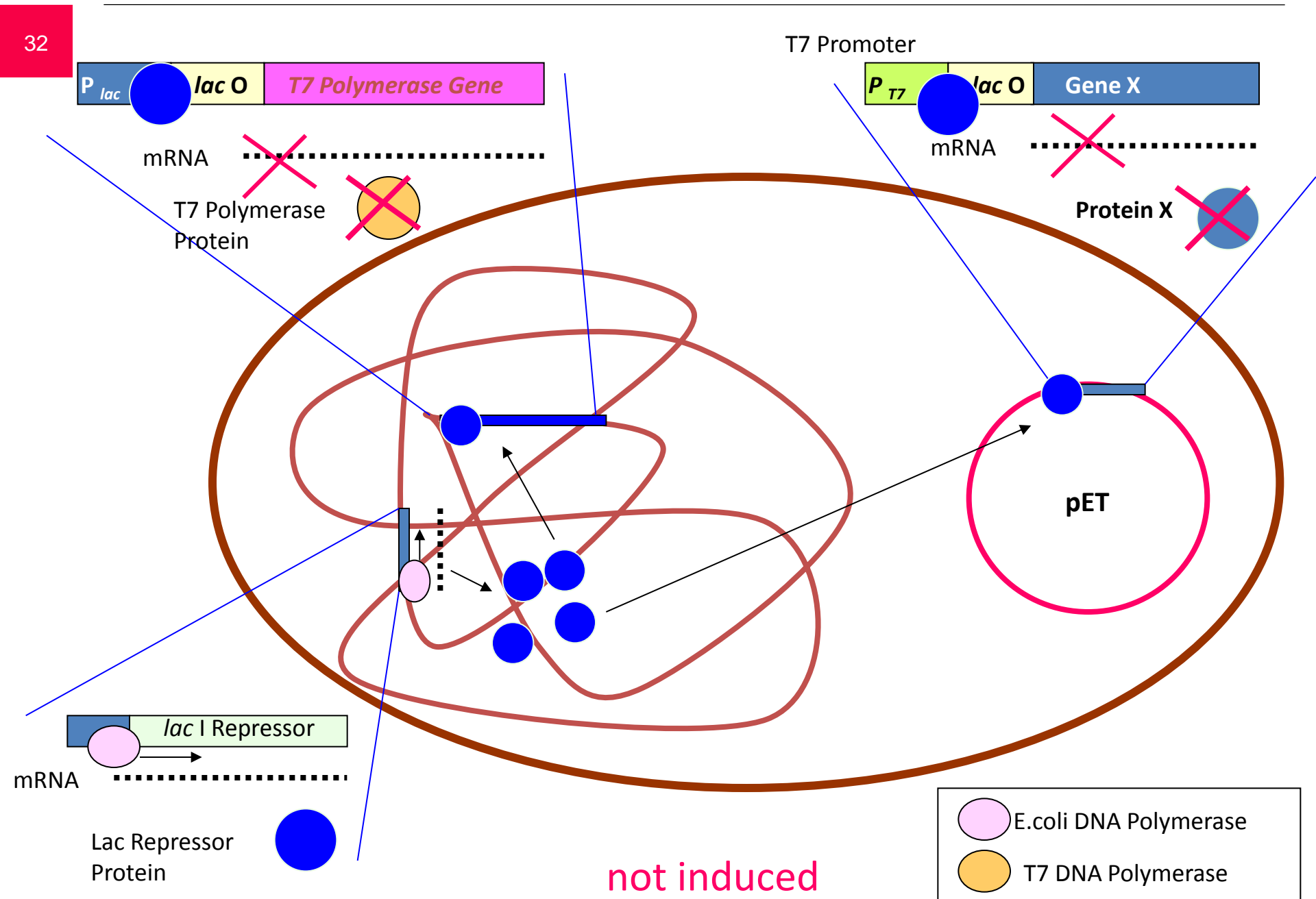

pET-Expression system

33

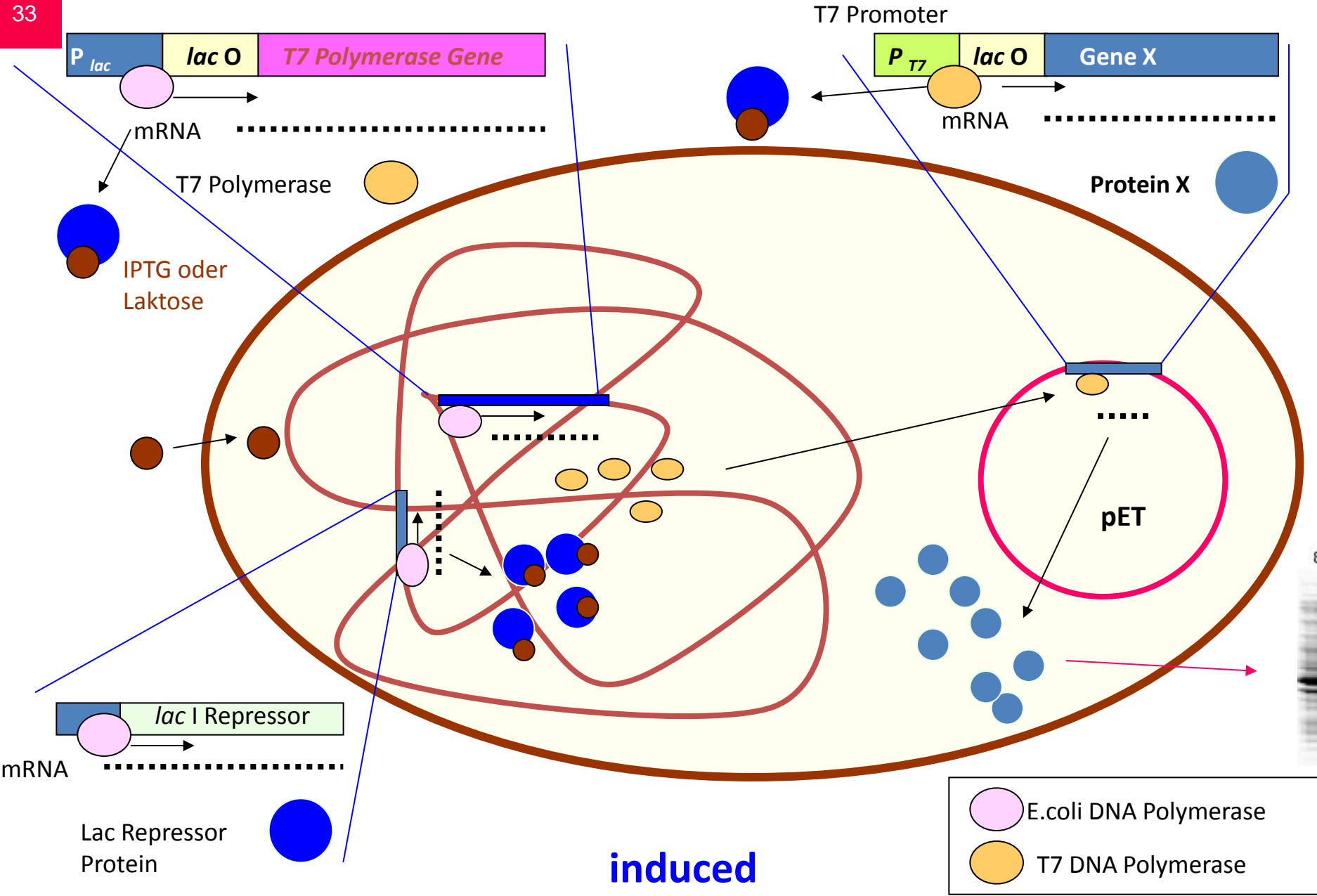

pETDuet-1 Vector

TB337 RevA 0903

	Cat. No.
pETDuet-1 DNA	71146-3
pETDuet-1 sequence landmarks	
T7 promoter-1	5404-5420
T7 transcription start-1	1
His•Tag [®] coding sequence	83-100
Multiple cloning sites-1 (<i>Nco</i> I– <i>Afl</i> II)	69-168
T7 promoter-2	214-230
T7 transcription start-2	231
Multiple cloning sites-2 (<i>Nde</i> I– <i>Avr</i> II)	297-438
S•Tag [™] coding sequence	366-410
T7 terminator	462-509
<i>lacI</i> coding sequence	3931-5013
pBR322 origin	2737
<i>bla</i> (Ap) coding sequence	1119-1976
f1 origin	547-994

pETDuet[™]-1 is designed for the coexpression of two target genes. The vector contains two multiple cloning sites (MCS), each of which is preceded by a T7 promoter/*lac* operator and a ribosome binding site (rbs). The vector also carries the pBR322-derived ColE1 replicon, *lacI* gene and ampicillin resistance gene. This vector can be used in combination with pACYCDuet[™]-1 (Cat. No. 71147-3) in an appropriate host strain for the coexpression of up to 4 target genes. Genes inserted into MCS1 can be sequenced using the pET Upstream Primer (Cat. No. 69214-3) and DuetDOWN1 Primer (Cat. No. 71179-3). Genes inserted into MCS2 can be sequenced using the DuetUP2 Primer (Cat. No. 71180-3) and T7 Terminator Primer (Cat. No. 69337-3).

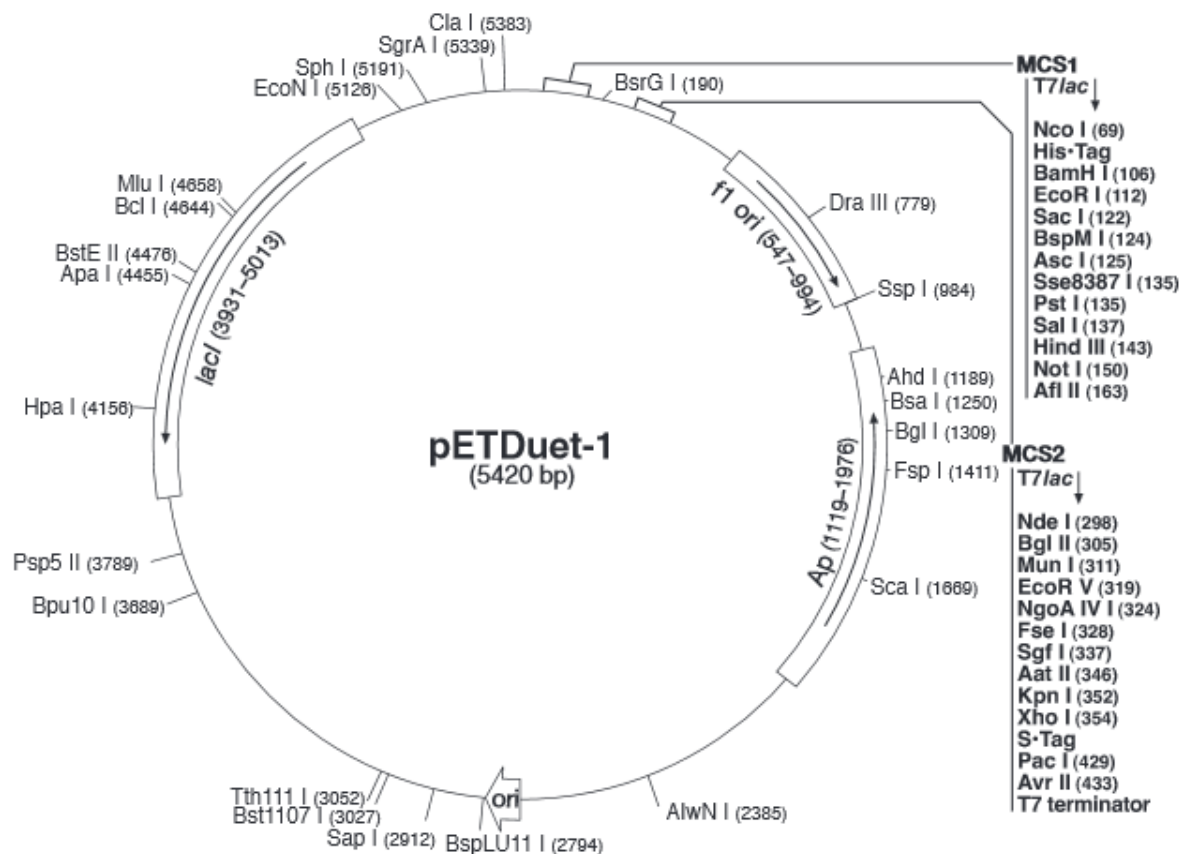

Bacteriophage Lambda Promoters

P_L and P_R

C_{I857} Lambda Repressor C_I thermosensitive mutant

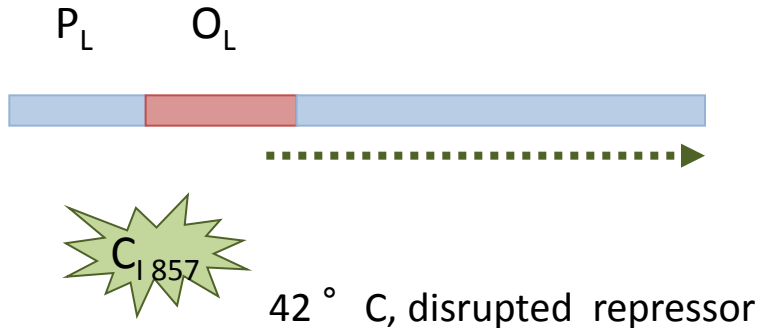
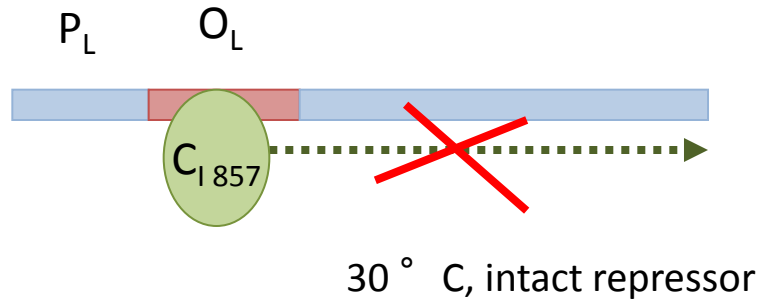

P_L based Expression Vector

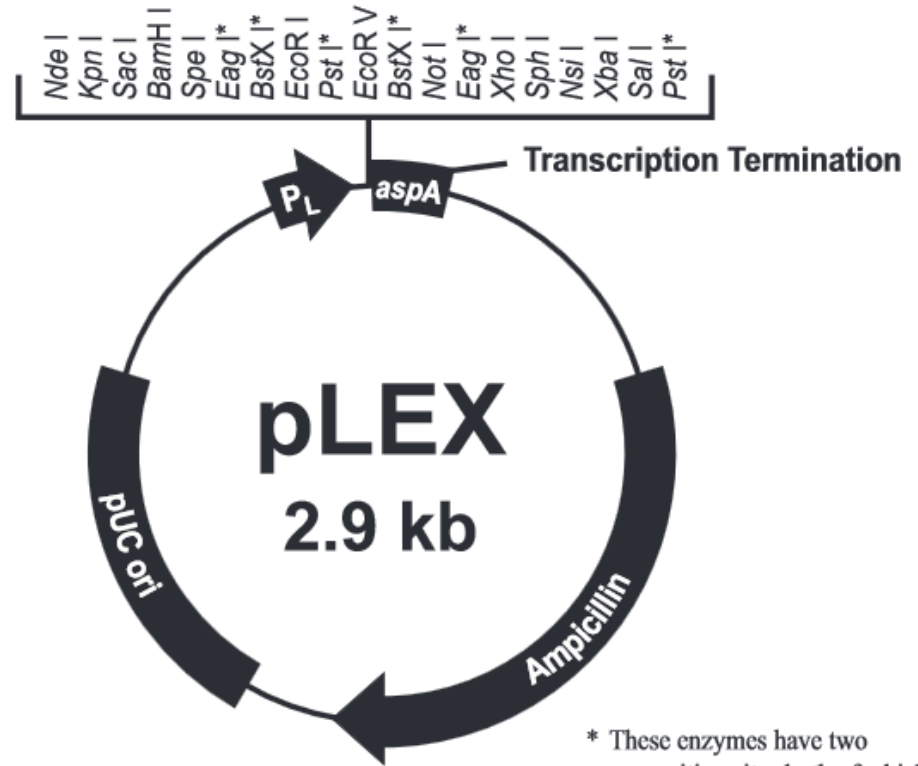

* These enzymes have two recognition sites both of which are found in the multiple cloning site.

Arabinose Operon based Expression system

The pBAD Expression System is based on the *araBAD* operon which controls the arabinose metabolic pathway in *E. coli*. It allows you to precisely modulate heterologous expression to levels that are optimal for recovering high yields of your protein of interest.

The pBAD/His vector offers the following key features:

- The PBAD promoter and the *araC* gene product for regulated expression of the gene of interest
- N-terminal polyhistidine tag for rapid purification of fusion proteins using ProBond™ resin
- Anti-Xpress™ epitope for detection of fusion proteins with the Anti-Xpress™ Antibody
- Enterokinase cleavage site to facilitate removal of the fusion partner
- Multiple cloning site in three reading frames to simplify subcloning in frame with the N-terminal polyhistidine tag
- Ampicillin resistance gene and ColE1 origin for selection and maintenance in *E. coli*

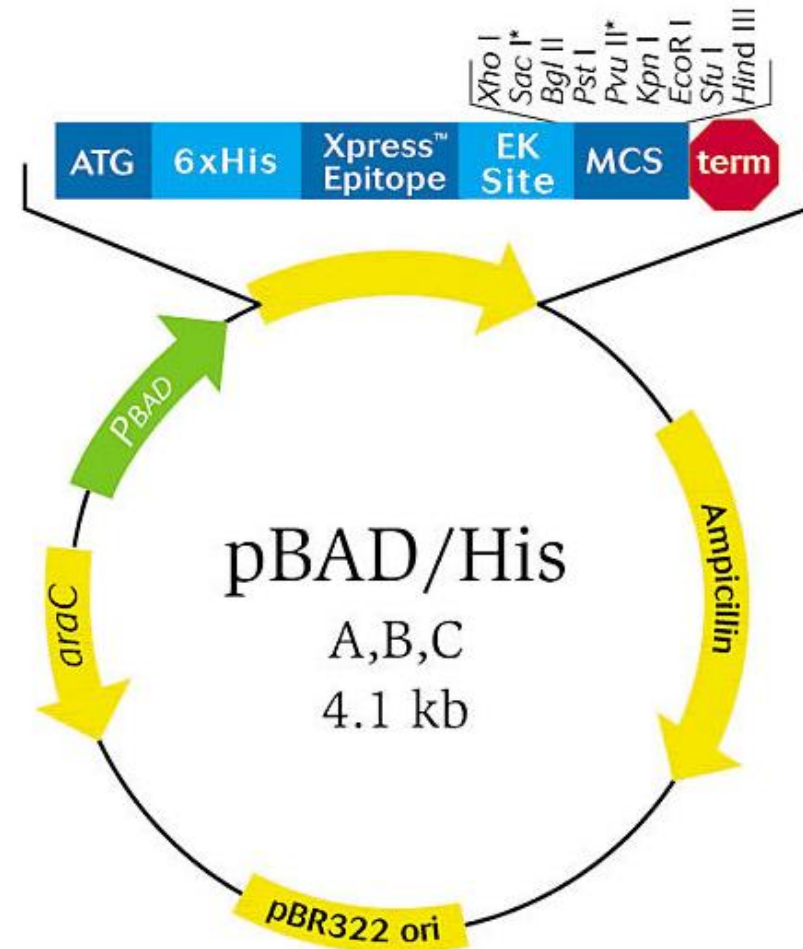

* Frame-dependent variations

Heterologous expression in prokaryotes – *E.coli*

Transcription

regulated promoters

lambda p_L , p_R

lac, *trp*, *tac*, *trc*, *araBAD*

T7

termination

rrnB (T1,T2), *trpT*

Lambda N gene (premature termination)

m-RNA stability

Translation

Initiation – SD sequence ...AGGAG....

elongation – codon usage

Protein Folding

Proteolysis

Lon, Clp, *htpR* (heat shock regulatory protein)

Posttranslational Processing

Plasmid copy number and segregation

m-RNA Stability

RNA has programmed half life

no good information available on factors determining decay

Secondary structures → Target for RNases

Sequence structure → determines secondary structure and
accessibility to RNases

Heterologous expression in prokaryotes – *E.coli*

Transcription

regulated promoters

lambda p_L , p_R

lac, *trp*, *tac*, *trc*, *araBAD*

T7

termination

rrnB (T1,T2), *trpt*

Lambda N gene (premature termination)

m-RNA stability

Translation

Initiation – SD sequence ...AGGAG....

elongation – codon usage

Protein Folding

Proteolysis

Lon, Clp, *htpR* (heat shock regulatory protein)

Posttranslational Processing

Plasmid copy number and segregation

Translation Initiation

- SD sequence ...AGGAG....
- Secondary structures

Translation elongation

- Codon usage
- Secondary structures
- Codon structure – translational frameshifting

AAA	AAA	AAA	UCA
Lys	Lys	Lys	Ser

AAA	AAA	AAU	CA
Lys			
	Lys	Lys	Ile

Translation - Prokaryotes

Shine-Dalgarno (SD) Sequence

rRNA 5' -GAUACCAUCCUCCUUA-3'

mRNAGGAGG.. (5-7bp) . . .AUG

Influences:

Secondary structure!! SD and AUG in unstructured region

Surrounding of SD and AUG!!!

Start

AUG	91%
GUG	8
UUG	1

one-cistron mRNA

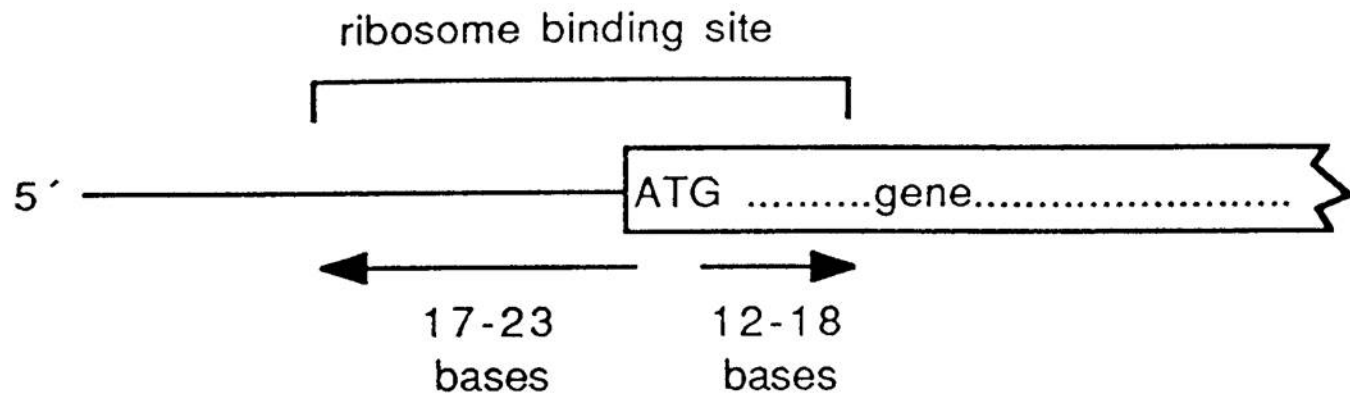

two-cistron mRNA

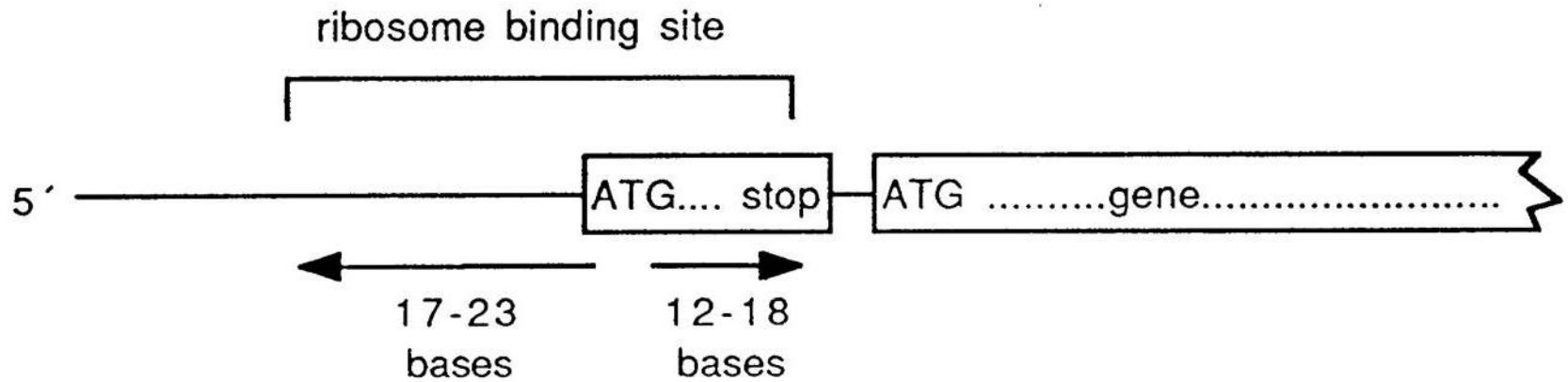

Translational coupling

Translational Coupling



Translation - Eukaryotes

Start Codon

mRNA 5'-CAP.....AUG

CAP structure essential for efficient translation initiation

Influences on Translation Efficiency:

Surrounding of AUG!!!

Kozak Consensus → not a ribosome binding site,
present with highly expressed genes

.....CC^A/_GCCAUGG..... mammalian

.....^A/_TA^A/_CA^A/_CAUGTCT^T/_C..... yeast

Table 3.2 The genetic code and codon usage in *E. coli* and humans

Codon	Amino acid	Frequency of use in:	
		<i>E. coli</i>	Human
GGG	Glycine	0.13	0.23
GGA	Glycine	0.09	0.26
GGU	Glycine	0.38	0.18
GGC	Glycine	0.40	0.33
GAG	Glutamic acid	0.30	0.59
GAA	Glutamic acid	0.70	0.41
GAU	Aspartic acid	0.59	0.44
GAC	Aspartic acid	0.41	0.56
GUG	Valine	0.34	0.48
GUA	Valine	0.17	0.10
GUU	Valine	0.29	0.17
GUC	Valine	0.20	0.25
GCG	Alanine	0.34	0.10
GCA	Alanine	0.22	0.22
GCU	Alanine	0.19	0.28
GCC	Alanine	0.25	0.40
AAG	Lysine	0.24	0.60
AAA	Lysine	0.76	0.40
AAU	Asparagine	0.39	0.44
AAC	Asparagine	0.61	0.56
AUG	Methionine	1.00	1.00
AUA	Isoleucine	0.07	0.14
AUU	Isoleucine	0.47	0.35
AUC	Isoleucine	0.46	0.51
ACG	Threonine	0.23	0.12
ACA	Threonine	0.12	0.27
ACU	Threonine	0.21	0.23
ACC	Threonine	0.43	0.38
UGG	Tryptophan	1.00	1.00
UGU	Cysteine	0.43	0.42
UGC	Cysteine	0.57	0.58
UGA	Stop	0.30	0.61
UAG	Stop	0.09	0.17
UAA	Stop	0.62	0.22
UAU	Tyrosine	0.53	0.42
UAC	Tyrosine	0.47	0.58
UUU	Phenylalanine	0.51	0.43
UUC	Phenylalanine	0.49	0.57
UCG	Serine	0.13	0.06
UCA	Serine	0.12	0.15
UCU	Serine	0.19	0.17
UCC	Serine	0.17	0.23
AGU	Serine	0.13	0.14
AGC	Serine	0.27	0.25
CGG	Arginine	0.08	0.19
CGA	Arginine	0.05	0.10
CGU	Arginine	0.42	0.09
CGC	Arginine	0.37	0.19

GUA	Valine	0.17	0.10
GUU	Valine	0.29	0.17
GUC	Valine	0.20	0.25
GCG	Alanine	0.34	0.10
GCA	Alanine	0.22	0.22
GCU	Alanine	0.19	0.28
GCC	Alanine	0.25	0.40
AAG	Lysine	0.24	0.60
AAA	Lysine	0.76	0.40
AAU	Asparagine	0.39	0.44
AAC	Asparagine	0.61	0.56
AUG	Methionine	1.00	1.00
AUA	Isoleucine	0.07	0.14
AUU	Isoleucine	0.47	0.35
AUC	Isoleucine	0.46	0.51
ACG	Threonine	0.23	0.12
ACA	Threonine	0.12	0.27
ACU	Threonine	0.21	0.23
ACC	Threonine	0.43	0.38
UGG	Tryptophan	1.00	1.00
UGU	Cysteine	0.43	0.42
UGC	Cysteine	0.57	0.58
UGA	Stop	0.30	0.61
UAG	Stop	0.09	0.17
UAA	Stop	0.62	0.22
UAU	Tyrosine	0.53	0.42
UAC	Tyrosine	0.47	0.58
UUU	Phenylalanine	0.51	0.43
UUC	Phenylalanine	0.49	0.57
UCG	Serine	0.13	0.06
UCA	Serine	0.12	0.15
UCU	Serine	0.19	0.17
UCC	Serine	0.17	0.23
AGU	Serine	0.13	0.14
AGC	Serine	0.27	0.25
CGG	Arginine	0.08	0.19
CGA	Arginine	0.05	0.10
CGU	Arginine	0.42	0.09
CGC	Arginine	0.37	0.19
CUA	Leucine	0.03	0.07
CUU	Leucine	0.10	0.12
CUC	Leucine	0.10	0.20
UUG	Leucine	0.11	0.12
UUA	Leucine	0.11	0.06
CCG	Proline	0.55	0.11
CCA	Proline	0.20	0.27
CCU	Proline	0.16	0.29

Table 3.2 The genetic code and codon usage in *E. coli* and humans

Codon	Amino acid	Frequency of use in:	
		<i>E. coli</i>	Humans
GGG	Glycine	0.13	0.23
GGA	Glycine	0.09	0.26
GGU	Glycine	0.38	0.18
GGC	Glycine	0.40	0.33
GAG	Glutamic acid	0.30	0.59
GAA	Glutamic acid	0.70	0.41
GAU	Aspartic acid	0.59	0.44
GAC	Aspartic acid	0.41	0.56
GUG	Valine	0.34	0.48
GUA	Valine	0.17	0.10
GUU	Valine	0.29	0.17
GUC	Valine	0.20	0.25
GCG	Alanine	0.34	0.10
GCA	Alanine	0.22	0.22
GCU	Alanine	0.19	0.28
GCC	Alanine	0.25	0.40
AAG	Lysine	0.24	0.60
AAA	Lysine	0.76	0.40
AAU	Asparagine	0.39	0.44
AAC	Asparagine	0.61	0.56
AUG	Methionine	1.00	1.00
AUA	Isoleucine	0.07	0.14
AUU	Isoleucine	0.47	0.35
AUC	Isoleucine	0.46	0.51
ACG	Threonine	0.23	0.12
ACA	Threonine	0.12	0.27
ACU	Threonine	0.21	0.23
ACC	Threonine	0.43	0.38
UGG	Tryptophan	1.00	1.00
UGU	Cysteine	0.43	0.42
UGC	Cysteine	0.57	0.58

UGA	Stop	0.30	0.61
UAG	Stop	0.09	0.17
UAA	Stop	0.62	0.22
UAU	Tyrosine	0.53	0.42
UAC	Tyrosine	0.47	0.58
UUU	Phenylalanine	0.51	0.43
UUC	Phenylalanine	0.49	0.57
UCG	Serine	0.13	0.06
UCA	Serine	0.12	0.15
UCU	Serine	0.19	0.17
UCC	Serine	0.17	0.23
AGU	Serine	0.13	0.14
AGC	Serine	0.27	0.25
CGG	Arginine	0.08	0.19
CGA	Arginine	0.05	0.10
CGU	Arginine	0.42	0.09
CGC	Arginine	0.37	0.19
AGG	Arginine	0.03	0.22
AGA	Arginine	0.04	0.21
CAG	Glutamine	0.69	0.73
CAA	Glutamine	0.31	0.27
CAU	Histidine	0.52	0.41
CAC	Histidine	0.48	0.59
CUG	Leucine	0.55	0.43
CUA	Leucine	0.03	0.07
CUU	Leucine	0.10	0.12
CUC	Leucine	0.10	0.20
UUG	Leucine	0.11	0.12
UUA	Leucine	0.11	0.06
CCG	Proline	0.55	0.11
CCA	Proline	0.20	0.27
CCU	Proline	0.16	0.29
CCC	Proline	0.10	0.33

Heterologous expression in prokaryotes – *E.coli*

Transcription

regulated promoters

lambda p_L , p_R

lac, *trp*, *tac*, *trc*, *araBAD*

T7

termination

rrnB (T1,T2), *trpt*

Lambda N gene (premature termination)

m-RNA stability

Translation

Initiation – SD sequence ...AGGAG....

elongation – codon usage

Protein Folding

Proteolysis

Lon, Clp, *htpR* (heat shock regulatory protein)

Posttranslational Processing

Plasmid copy number and segregation

Protein Folding

Translation Conditions

Elongation velocity

Codon Structure – Pausing

Domain folding

Disulfide Bond Formation

Redox Conditions

E.coli Cytosol → bad conditions - reductive

E.coli Periplasm → optimal conditions - oxidative

Chaperones

Inclusion Body Formation

Expression velocity → Translation

Protein Folding

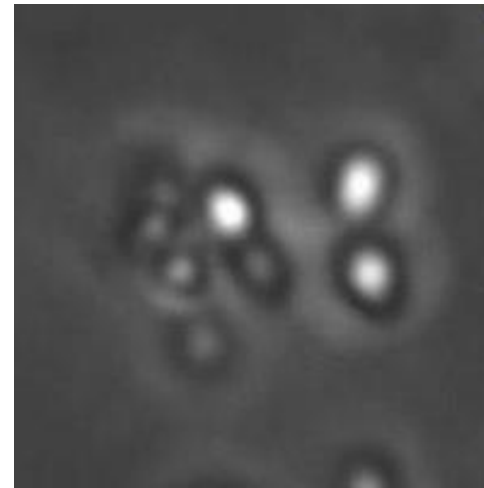

The Department of
Surface Biotechnology
with
the Center for Surface
Biotechnology, Box 577,
BMC, 751 23 Uppsala

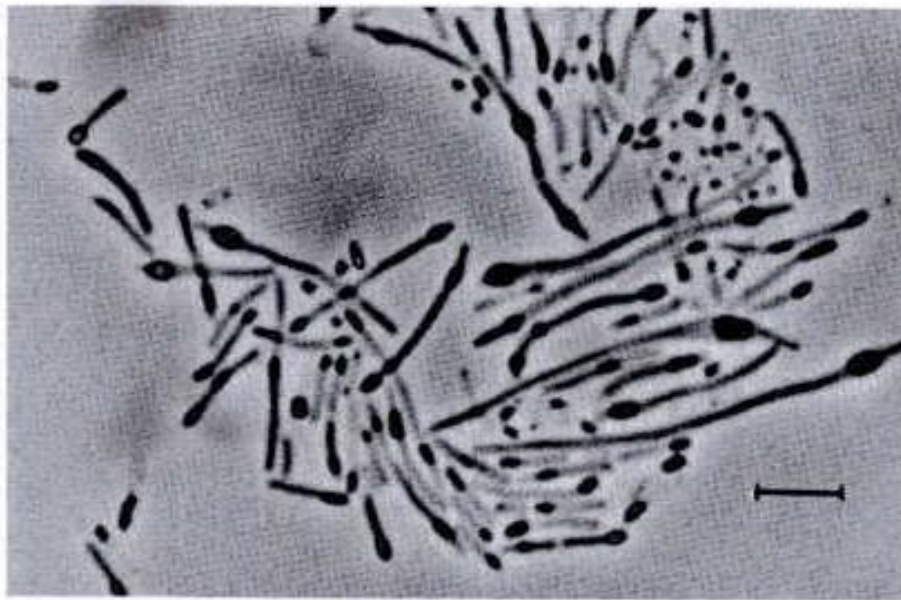
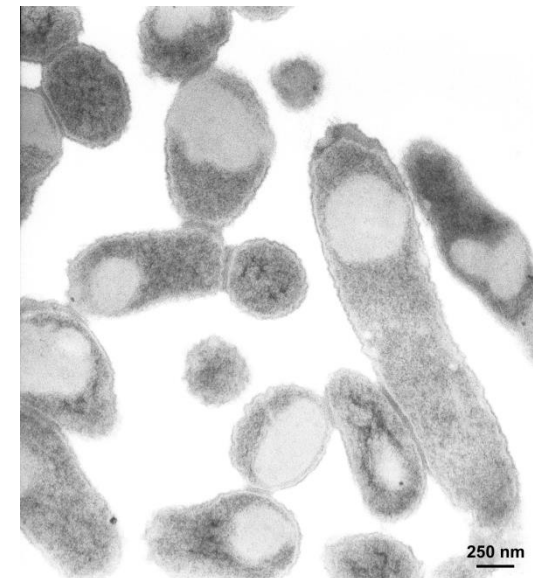

Figure 3 Phase-contrast microscopy of HB101/pBSF2-SD7 cells overproducing hIL-6 (bar equals 2 μm).
(From Ref. 61)



www.boku.ac.at/IAM/dn/EM424_23.jpg

20.10.16

Heterologous expression in prokaryotes – *E.coli*

Transcription

regulated promoters

lambda p_L , p_R

lac, *trp*, *tac*, *trc*, *araBAD*

T7

termination

rrnB (T1,T2), *trpt*

Lambda N gene (premature termination)

m-RNA stability

Translation

Initiation – SD sequence ...AGGAG....

elongation – codon usage

Protein Folding

Proteolysis

Lon, Clp, *htpR* (heat shock regulatory protein)

Posttranslational Processing

Plasmid copy number and segregation

Post-translational modifications

Side Chain Modifications

Glycosylation, Phosphorylation, Sulfatation, etc.

Proteolytic Processing

ss Cleavage

Pro-protein processing

N/C-terminal Processing

Posttranslational Processing in prokaryotes – *E.coli*

N-terminal processing – the problem of Met

f-Met deformylase

methionine aminopeptidase (MAP) of *E.coli*

peptidase M (*S. typhimurium*)

aminopeptidase M: Exopeptidase → X-Pro

aminopeptidase P: NH₂-X-/Pro

dipeptidylaminopeptidase I (DAP-I, Cathepsin C) → not at NH₂ Pro/Arg/Lys

protein fusion strategies

sequence specific proteases

tags

Table 6.5 α -Amylase gene copy number and activity in *B. subtilis*

Copies/genome	Activity (U/mL of mid-log cells)
2	500
5	2,300
7	3,100
8	3,400
9	4,400
Multicopy plasmid	700

Adapted from Kallio et al., 1987, *Appl. Microbiol. Biotechnol.* 27:64–71.

Table 6.6 Effect of plasmid copy number on host cell growth rate

<i>E. coli</i> HB101 with plasmid:	Plasmid copy number	Relative specific growth rate
None	0	1.00
A	12	0.92
B	24	0.91
C	60	0.87
D	122	0.82
E	408	0.77

Adapted from Seo and Bailey, 1985, *Biotechnol. Bioeng.* 27:1668–1674.

The different plasmids, designated A, B, C, D and E, encode only β -lactamase and are all the same size. The growth rates were normalized to the growth rate value for *E. coli* HB101 without a plasmid.

Metabolic load

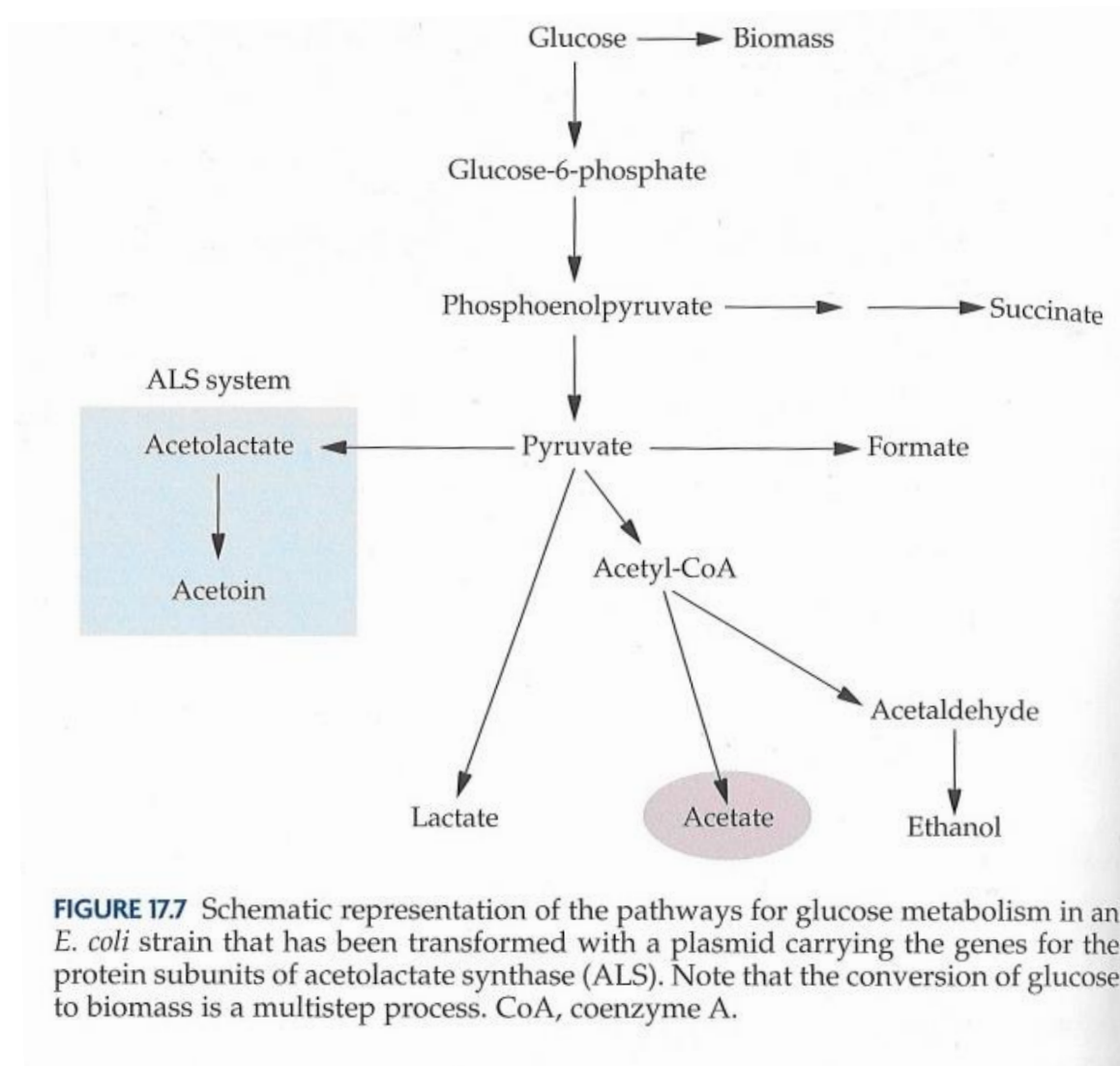

Gene Fusion Strategies

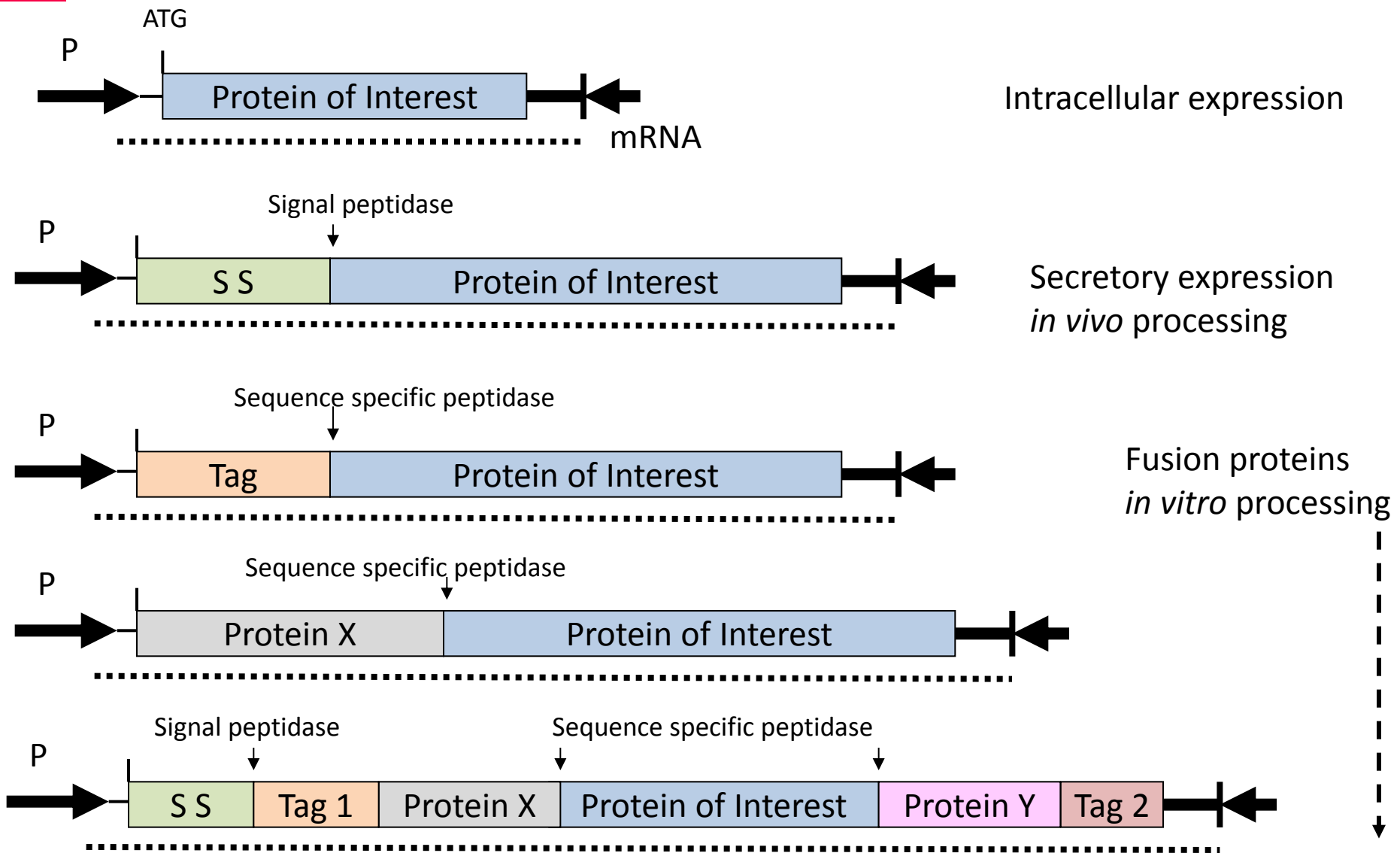

Table 6.3 Some fusion systems used to facilitate the purification of foreign proteins produced in *E. coli*

Fusion partner	Size	Ligand	Elution condition
ZZ	14 kDa	IgG	Low pH
His tail	6–10 aa	Ni ²⁺	Imidazole
Strep-tag	10 aa	Streptavidin	Iminobiotin
PinPoint	13 kDa	Streptavidin	Biotin
MBP	40 kDa	Amylose	Maltose
β -Lactamase	27 kDa	Phenyl-boronate	Borate
GST	25 kDa	Glutathione	Reducing agent
Flag	8 aa	Specific MAb	Low calcium

Adapted from Nygren et al., 1994, *Trends Biotechnol.* 12:184–188.

Abbreviations: aa, amino acids; kDa, kilodaltons; ZZ, a fragment of *Staphylococcus aureus* protein A; His, histidine; Strep-tag, a peptide with affinity for streptavidin; PinPoint, a protein fragment which is

Table 2 Sequence and size of affinity tags

Tag	Residues	Sequence	Size (kDa)
Poly-Arg	5–6 (usually 5)	RRRRR	0.80
Poly-His	2–10 (usually 6)	HHHHH	0.84
FLAG	8	DYKDDDDK	1.01
Strep-tag II	8	WSHPQFEK	1.06
c-myc	11	EQKLISEEDL	1.20
S-	15	KETAAAKFERQHMD S	1.75
HAT-	19	KDHLIHNVHKEFHAAHANK	2.31
3x FLAG	22	DYKDHDGDYKDHDIDYKDDDDK	2.73
Calmodulin-binding peptide	26	KRRWKKNFIAVSAANRFKKISSSGAL	2.96
Cellulose-binding domains	27–189	Domains	3.00– 20.00
SBP	38	MDEKTTGWRGGHVVEGLAGELEQLRARLEHHFQGGQREP	4.03
Chitin-binding domain	51	TNPGVSAWQVNTA YTAGQLVTYNGKTYKCLQPHTSLAGWEP SNV PALWQLQ	5.59
Glutathione S-transferase	211	Protein	26.00
Maltose-binding protein	396	Protein	40.00

Table 1 Matrices and elution conditions of affinity tags

Affinity tag	Matrix	Elution condition
Poly-Arg	Cation-exchange resin	NaCl linear gradient from 0 to 400 mM at alkaline pH>8.0
Poly-His	Ni ²⁺ -NTA, Co ²⁺ -CMA (Talon)	Imidazole 20–250 mM or low pH
FLAG	Anti-FLAG monoclonal antibody	pH 3.0 or 2–5 mM EDTA
Strep-tag II	Strep-Tactin (modified streptavidin)	2.5 mM desthiobiotin
c-myc	Monoclonal antibody	Low pH
S	S-fragment of RNaseA	3 M guanidine thiocyanate, 0.2 M citrate pH 2, 3 M magnesium chloride
HAT (natural histidine affinity tag)	Co ²⁺ -CMA (Talon)	150 mM imidazole or low pH
Calmodulin-binding peptide	Calmodulin	EGTA or EGTA with 1 M NaCl
Cellulose-binding domain	Cellulose	Family I: guanidine HCl or urea>4 M Family II/III: ethylene glycol
SBP	Streptavidin	2 mM Biotin
Chitin-binding domain	Chitin	Fused with intein: 30–50 mM dithiothreitol, β -mercaptoethanol or cysteine
Glutathione S-transferase	Glutathione	5–10 mM reduced glutathione
Maltose-binding protein	Cross-linked amylose	10 mM maltose

Enterokinase

D-D-D-D-K-X₁

TEV protease

E-X-X-Y-X-Q-S

 α -thrombinX₄-X₃-P-R[K]-X₁-
X₂

L - V - P - R G - S

Site of
cleavage of
factor X_aX_a linker sequence

... Thr-Ala-Glu-Gly-Gly-Ser-Ile-Glu-Gly-Arg-Val-His-Leu ...

Table 4 Cleavage (%) of enterokinase through densitometry (Hosfield and Lu 1999) based on the amino acid residue X₁. The sequence...-GSDYKDDDDK-X₁-ADQLTEEQIA-... of a GST-calmodulin fusion protein was tested using 5 mg protein digested with 0.2 Uof enterokinase for 16 h at 37 °C

Amino acid in position X ₁	Cleavage of enterokinase (%)
Alanine	88
Methionine	86
Lysine	85
Leucine	85
Asparagine	85
Phenylalanine	85
Isoleucine	84
Aspartic acid	84
Glutamic acid	80
Glutamine	79
Valine	79
Arginine	78
Threonine	78
Tyrosine	78
Histidine	76
Serine	76
Cysteine	74
Glycine	74
Tryptophan	67
Proline	61

Figure 6.6 Proteolytic cleavage of a fusion protein by blood coagulation factor X_a. The factor X_a recognition sequence (X_a linker sequence) lies between the amino acid sequences of two different proteins. A functional cloned gene protein (with Val at its N terminus) is released after cleavage.

Tag purification strategies

1 Concentrate secreted protein mixture

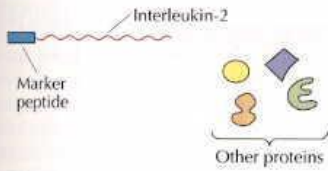

2 Prepare immunoaffinity column

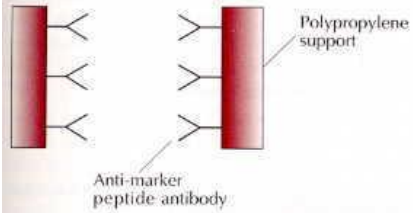

3 Add secreted protein mixture to the column

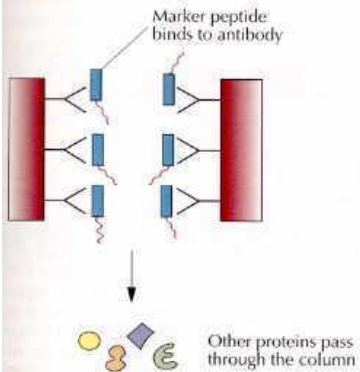

4 Elute fusion protein

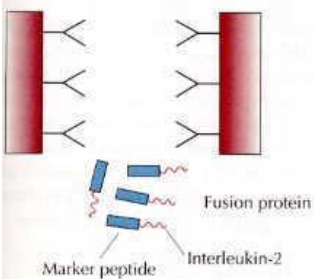
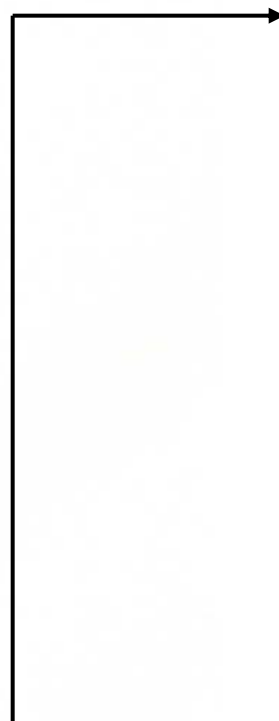

Figure 6.8 Immunoaffinity chromatographic purification of a fusion protein. An antibody that binds to the marker peptide of the fusion protein (anti-marker peptide antibody) is attached to a solid polypropylene support. The secreted proteins are passed through the column containing the bound antibody. The marker peptide portion of the fusion protein is bound to the antibody, and the other proteins pass through. The immunopurified fusion protein can then be selectively eluted from the column.

Removal of Tag



Proteolytic cleavage of Tag

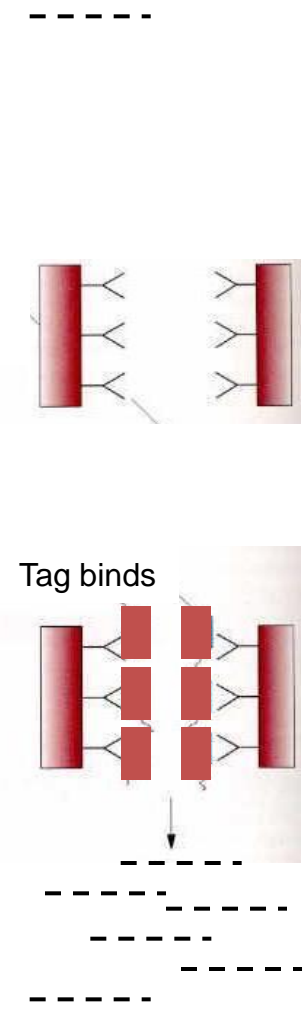
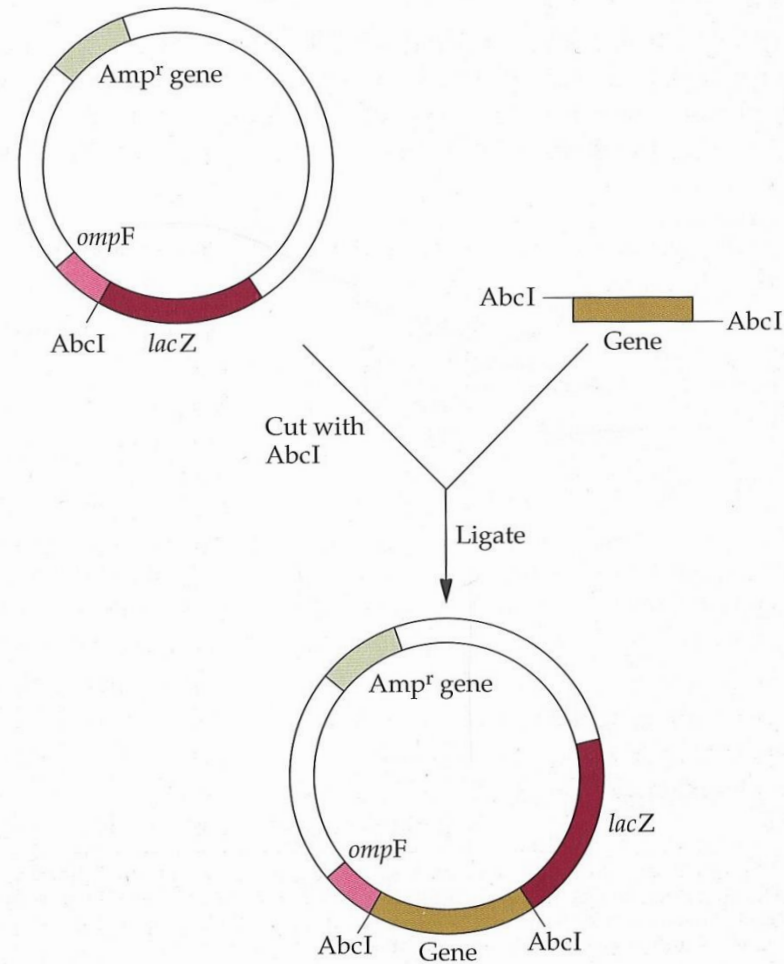

FIGURE 6.11 A fusion protein cloning vector. The plasmid contains an ampicillin resistance (Amp^r) gene as the selectable marker, a DNA sequence encoding the N-terminal segment of the *E. coli* outer membrane protein (*ompF*), a restriction endonuclease site (*AbcI*) for cloning, and a truncated β -galactosidase gene (*lacZ*). The cloned gene (Gene) is inserted into the *AbcI* site. After transcription and translation, a tribrid protein is produced consisting of OmpF–target protein–LacZ.



Examples for fusion strategies

For *E. coli*:

Maltose binding protein
Thioredoxin reductase

Generally: well soluble proteins
Well folded proteins

Fusions can help for:

Translation initiation

Folding

Protein detection: Antibodies against
Fusion partner (also with small tags)

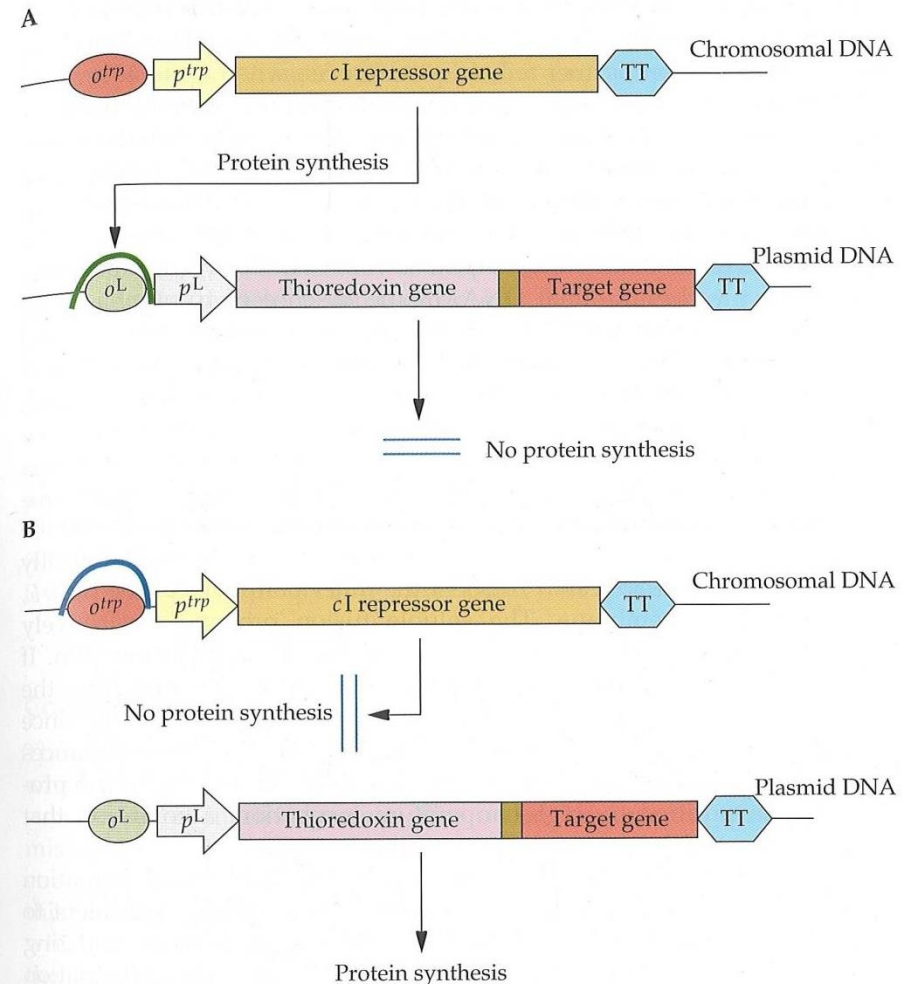

FIGURE 6.21 Regulation of the synthesis of a thioredoxin–target protein fusion in the absence (A) or presence (B) of tryptophan in the growth medium. The arrows labeled p^{trp} and p^L indicate the direction of transcription. o^{trp} , the operator region where the *trp* repressor protein binds; o^L , the operator region where the *cI* repressor binds; p^{trp} , the *trp* promoter; p^L , the leftward promoter from bacteriophage λ ; TT, transcription termination region. The box between the thioredoxin and target genes indicates the DNA region that codes for the peptide that acts as the enterokinase cleavage site; the horseshoes indicate the binding of a repressor protein to its operator region.

Eukaryotic Expression Systems

Fungi – Yeasts

Insect Cells

Plant Cells

Mammalian Cells

Mouse

Hamster

Avian

Human

Transgenic Plants

Transgenic Animals

FIGURE 7.7 *S. cerevisiae* expression vector. The cDNA for human Cu/Zn-SOD was cloned between the promoter (*GAPDp*) and termination–polyadenylation sequence (*GAPDt*) of the *S. cerevisiae* glyceraldehyde phosphate dehydrogenase gene. The *LEU2* gene that was cloned between segments of the yeast 2 μ m plasmid DNA encodes a functional enzyme of the leucine biosynthesis pathway. The yeast origin of replication is included in the 2 μ m plasmid DNA. The ampicillin resistance (*Amp^r*) gene and the *E. coli* origin of replication (*ori^E*) are derived from plasmid pBR322.

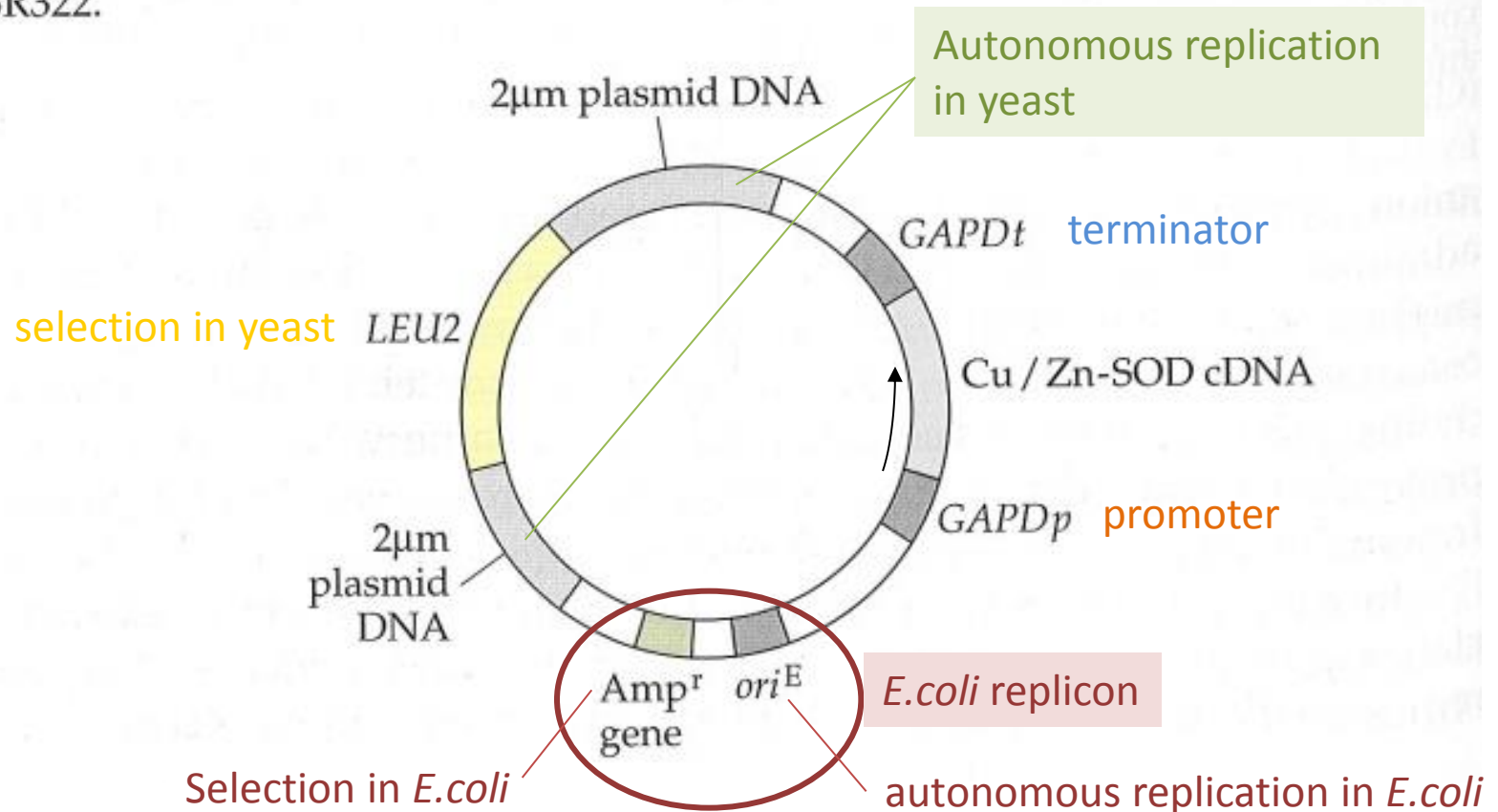

S.cerevisiae Expression vectors

2 μ -based multicopy vector

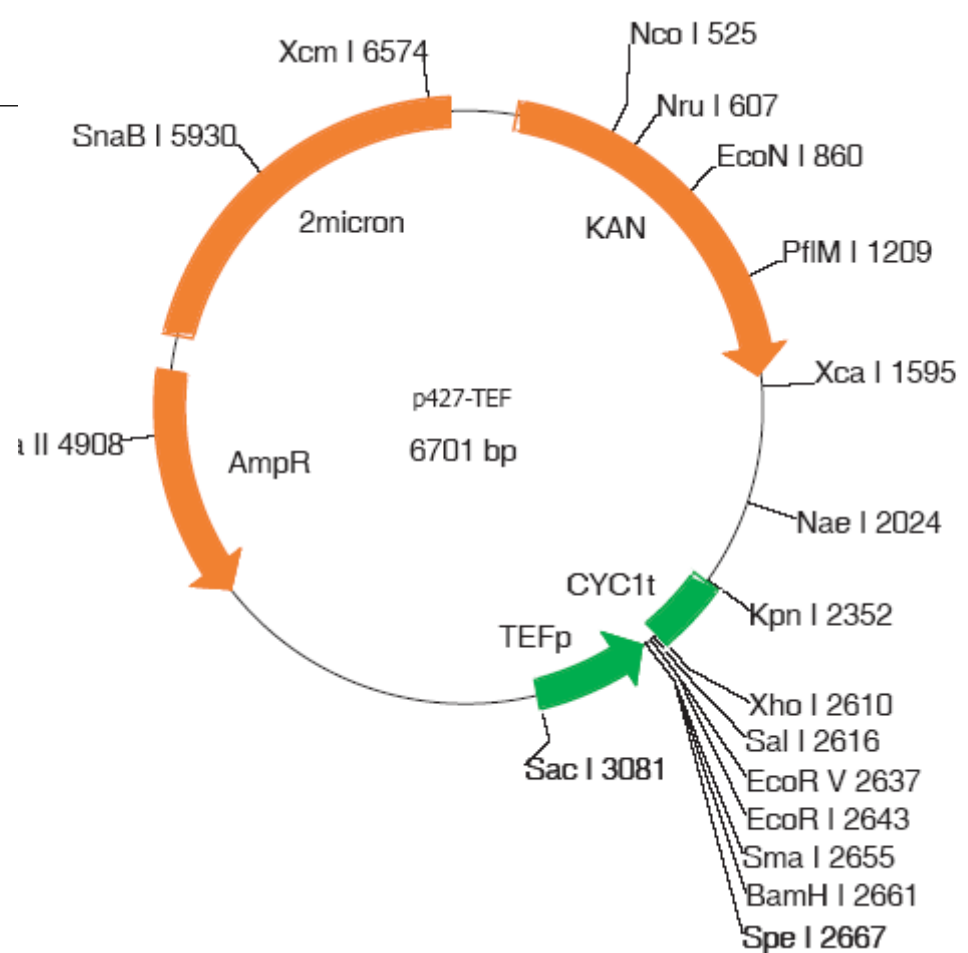
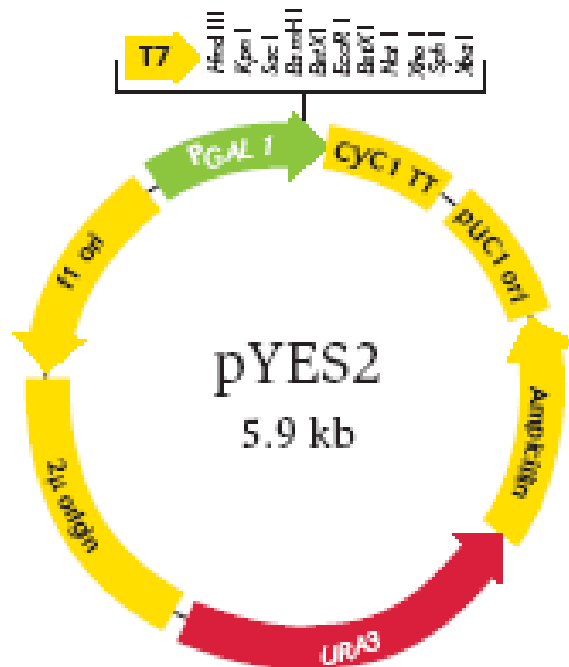

Vector features

TEFp TEF1 promoter (nt 2673-3081)

CYC1t *S. cerevisiae* CYC1 terminator (nt 2352-2610)

KAN Kanamycine resistance gene (aminoglycoside phosphotransferase), allows selection in yeast using 200 mg/ml G418 (nt 190-1571)

2micron Origin of replication derived from the endogenous yeast 2m circle. Allows propagation of plasmids in yeast at high copy numbers (10-50 copies/cell, nt 5291-6637)

AmpR Ampicillin resistance gene (nt 4300-5158)

GAL4 regulatory system

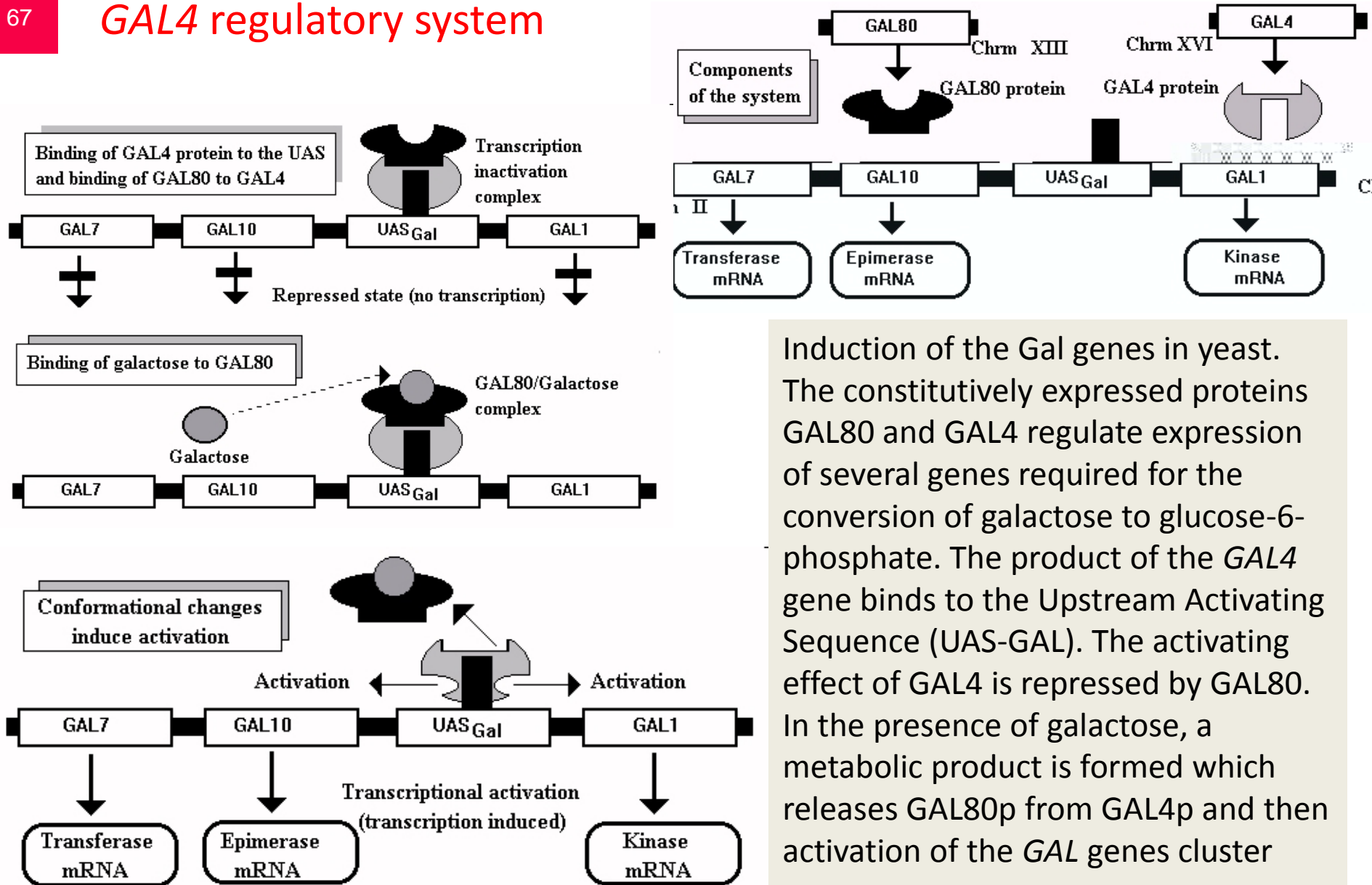

21.10.16

Protein Expression in *Pichia pastoris*

- Methylophilic yeast

Two alcohol oxidase genes: *AOX1*, *AOX2*

AOX1: 5 % of total mRNA, 30 % of total protein

- Well established commercial expression system

- More than 300 proteins successfully expressed

(bacterial, viral, fungal, plant, protozoan, invertebrate, vertebrate → 120 human proteins)

- High cell density fermentation (>100 g/L) on simple media

- No switch to anaerobic fermentation (ethanol problem)

- Stable integration into host chromosome

- Intracellular and secretory production capacities

- Advantages of a eukaryotic host cell – but simple system

Glycosylation (N-linked, high-mannose type)

Post-translational processing

Pichia expression tools

- Promoters

AOX1, GAP

- Selection marker

HIS4, ARG4, Zeocin^R, Blastidicin^R, Kanamycin^R (G418)

- Signal sequences

PHO1, alpha-Factor

- Host strains

*X-33 (wt), GS115 (his4), KM 71 (aox1::arg4 his4),
KM71H (aox1::arg4), SMD1168 (pep4 his4), SMD1168H (pep4)
CBS 7435 (WZ or $\Delta aox1$ or $\Delta his4$ knockouts)*

Integration in *Pichia pastoris*

Gene replacement at *AOX1*
phenotype: Mut^S

Single cross-over integration of circular molecules
AOX1 (5' and 3' regions)
HIS4
GAP

Tandem repeat multicopy integration

Ectopic integration events

Integration vector for *Pichia pastoris*

FIGURE 7.10 *P. pastoris* integrating expression vector. The gene of interest (GOI) is cloned between the promoter (*AOX1p*) and termination-polyadenylation sequence (*AOX1t*) of the *P. pastoris* alcohol oxidase 1 gene. The *HIS4* gene encodes a functional histidinol dehydrogenase of the histidine biosynthesis pathway. The ampicillin resistance (*Amp^r*) gene and an origin of replication (*ori^E*) function in *E. coli*. The segment marked 3' *AOX1* is a piece of DNA from the 3' end of the alcohol oxidase 1 gene of *P. pastoris*. A double recombination event between the *AOX1p* and 3' *AOX1* regions of the vector and the homologous segments of chromosome DNA results in the insertion of the DNA carrying the gene of interest and the *HIS4* gene.

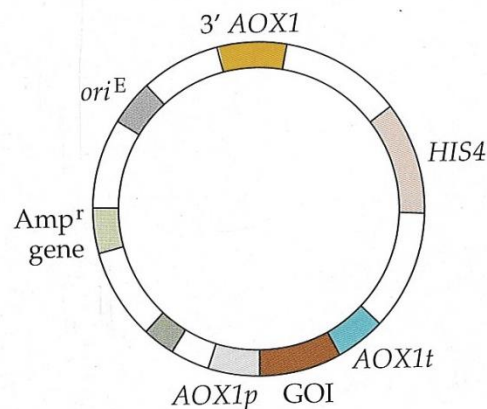

Gene Replacement

Figure 7.6 Integration of part of an expression vector into the alcohol oxidase 1 gene of *P. pastoris*. The double crossover event occurs within the *AOX1p* and 3'-*AOX1* DNA segments (shown at the top). This event results in the integration of the input DNA into the genomic DNA and the loss of most of the alcohol oxidase 1 gene from the host chromosome (shown at the bottom). The *HIS4* gene product enables cells with integrated DNA to grow on medium lacking histidine. In the presence of methanol, the *AOX1p* region drives the transcription of the *HBsAg* gene. The *AOX1t* segment provides transcription termination and polyadenylation signals for the *HBsAg* gene.

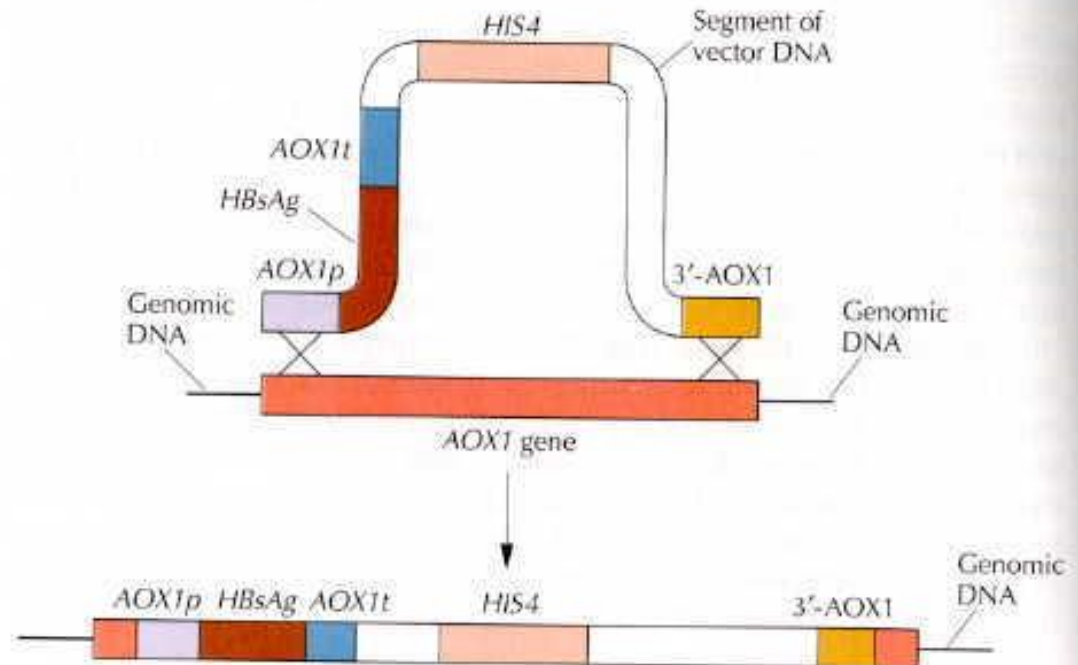
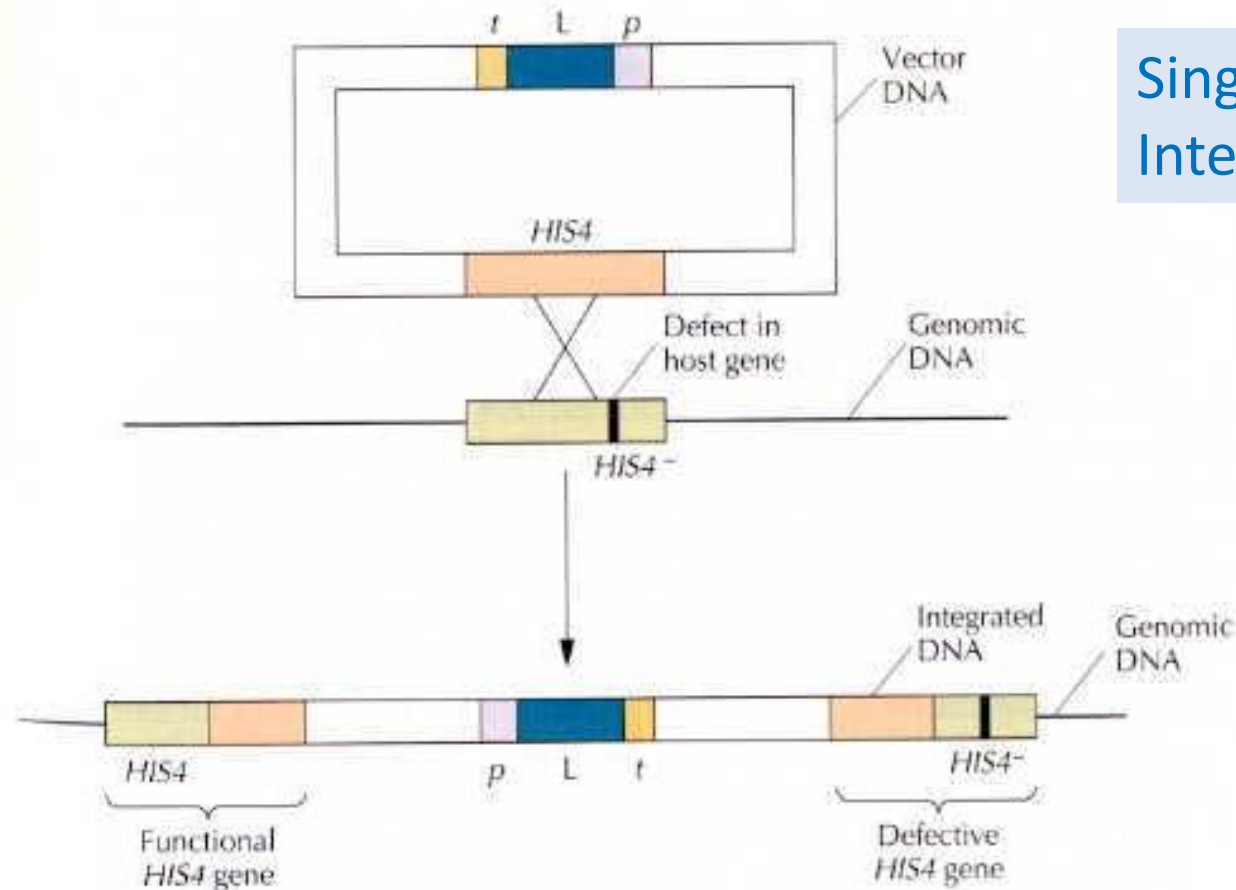
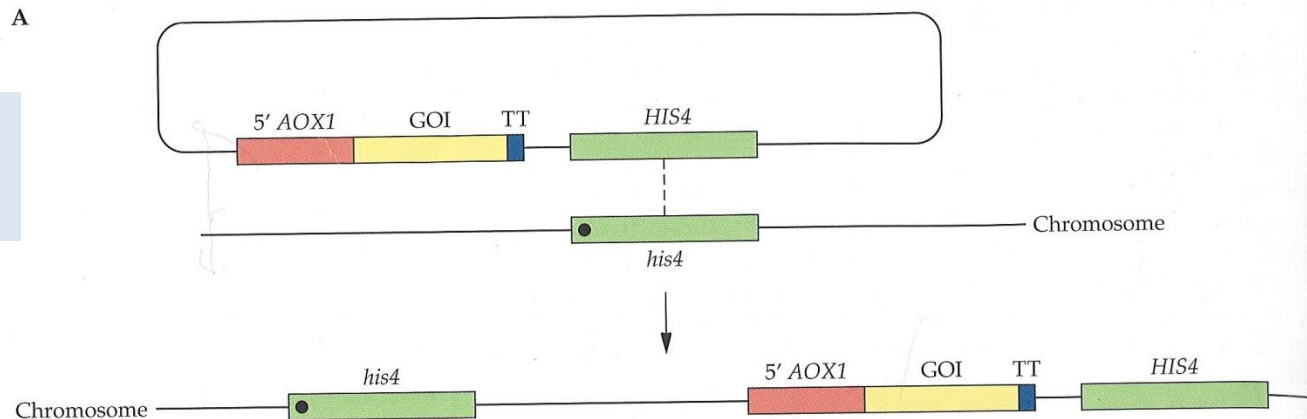

Figure 7.7 Integration of an expression vector into the defective chromosomal *HIS4*⁻ gene of *P. pastoris*. The input DNA is a plasmid that is first introduced by transformation into a histidine-requiring *P. pastoris* strain. A single crossover within the *HIS4* gene of the plasmid and the *HIS4*⁻ gene of the host cell results in the integration of the entire plasmid, which then is flanked by the functional *HIS4* gene and the defective *HIS4*⁻ gene. The letters *p*, *L*, and *t* denote the *AOX1* promoter sequence, bovine lysozyme C2 cDNA, and *AOX1* termination-polyadenylation signal sequence, respectively. The black bar in the *HIS4*⁻ gene represents the defective sequence.



Single-site
Integration

Single-site Integration



Gene Replacement

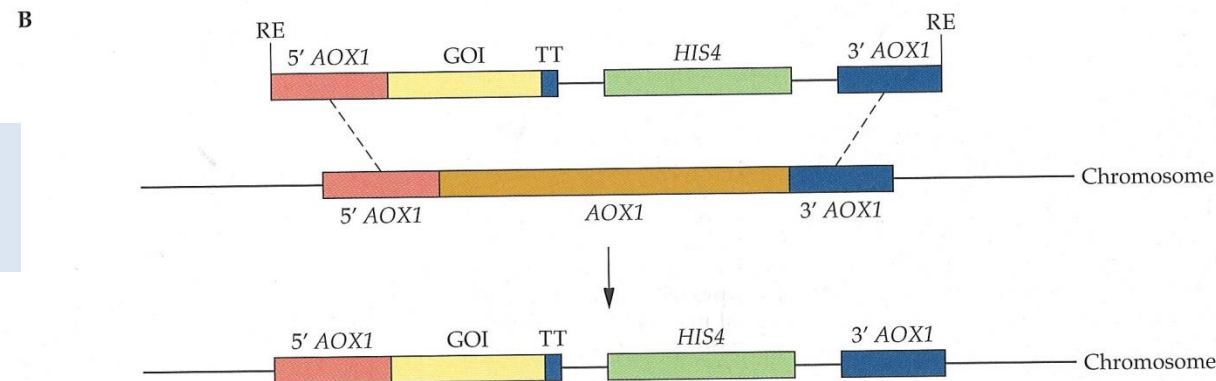
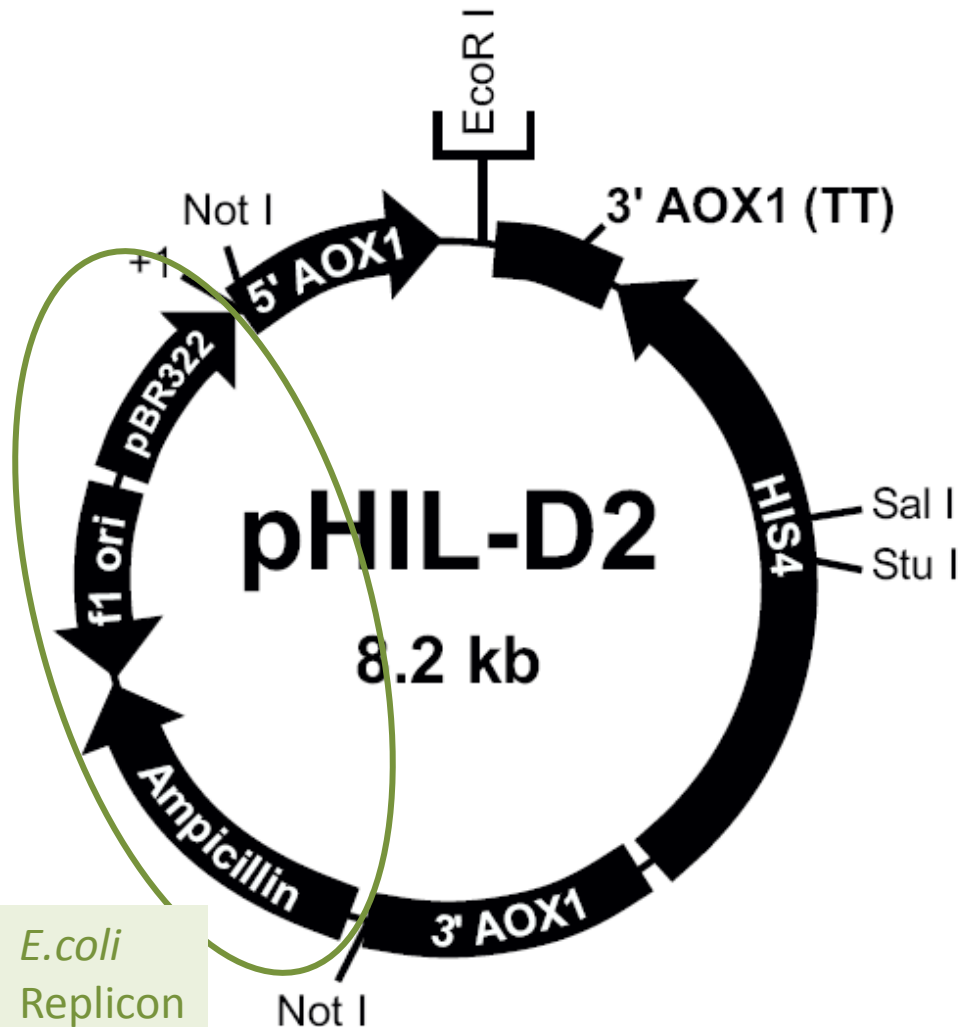

FIGURE 7.11 Integration of DNA into a specific *P. pastoris* chromosome site by single **(A)** or double **(B)** recombination. **(A)** A single recombination (dashed line) between the *HIS4* gene of an intact circular plasmid and a chromosome *his4* mutant gene results in the integration of the entire vector, including the gene of interest (GOI) with the *AOX1* promoter in the 5' *AOX1* DNA segment and the transcription-polyadenylation sequence from the *AOX1* gene (TT), into the chromosome. The inserted DNA is flanked by recombined mutant *his4* and functional *HIS4* genes. The dot in the *his4* gene represents the mutation. **(B)** A double recombination (dashed lines) between the cloned 5' *AOX1* and 3' *AOX1* DNA segments of a restriction endonuclease (RE) linearized DNA fragment from the vector and the corresponding chromosome regions results in the integration of the gene of interest (GOI) with the *AOX1* promoter in the 5' *AOX1* segment, the termination-polyadenylation sequence from the *AOX1* gene (TT), and a functional *HIS4* gene. The chromosome *AOX1* coding region is lost as a result of the recombination event.

Vector for Intracellular Expression



Comments for pHIL-D2:
8209 nucleotides

5' AOX1 promoter fragment: bases 14-941

5' AOX1 primer site: bases 868-888

EcoR I Site: bases 956-961

3' AOX1 primer site: bases 1036-1056

3' AOX1 transcription

termination (TT) fragment: bases 963-1295

HIS4 ORF: bases 4223-1689

3' AOX1 fragment: bases 4578-5334

Ampicillin resistance gene: bases 5686-6546

f1 origin of replication: bases 7043-6588

pBR322 origin: bases 7138-7757

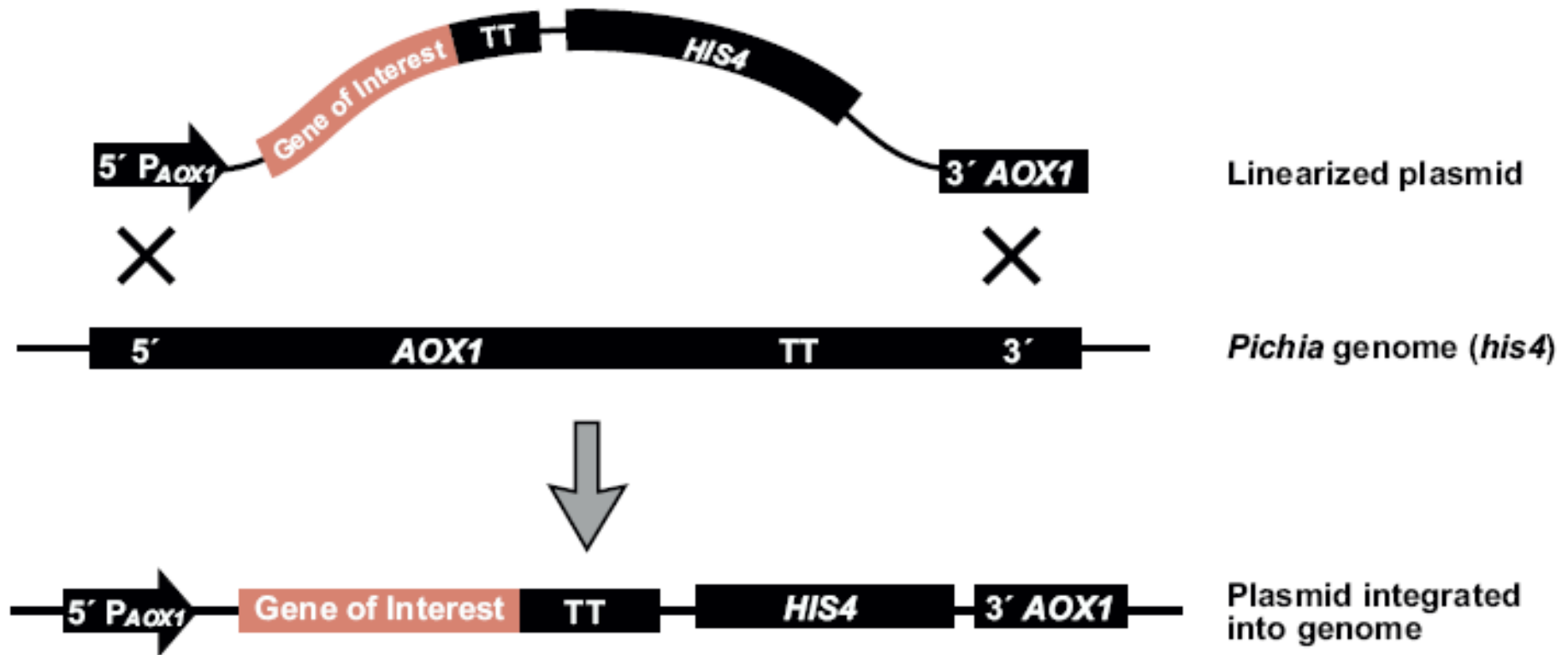

Vector for Intracellular Expression

pHILD2

78

Promoter (app. 900 bp)

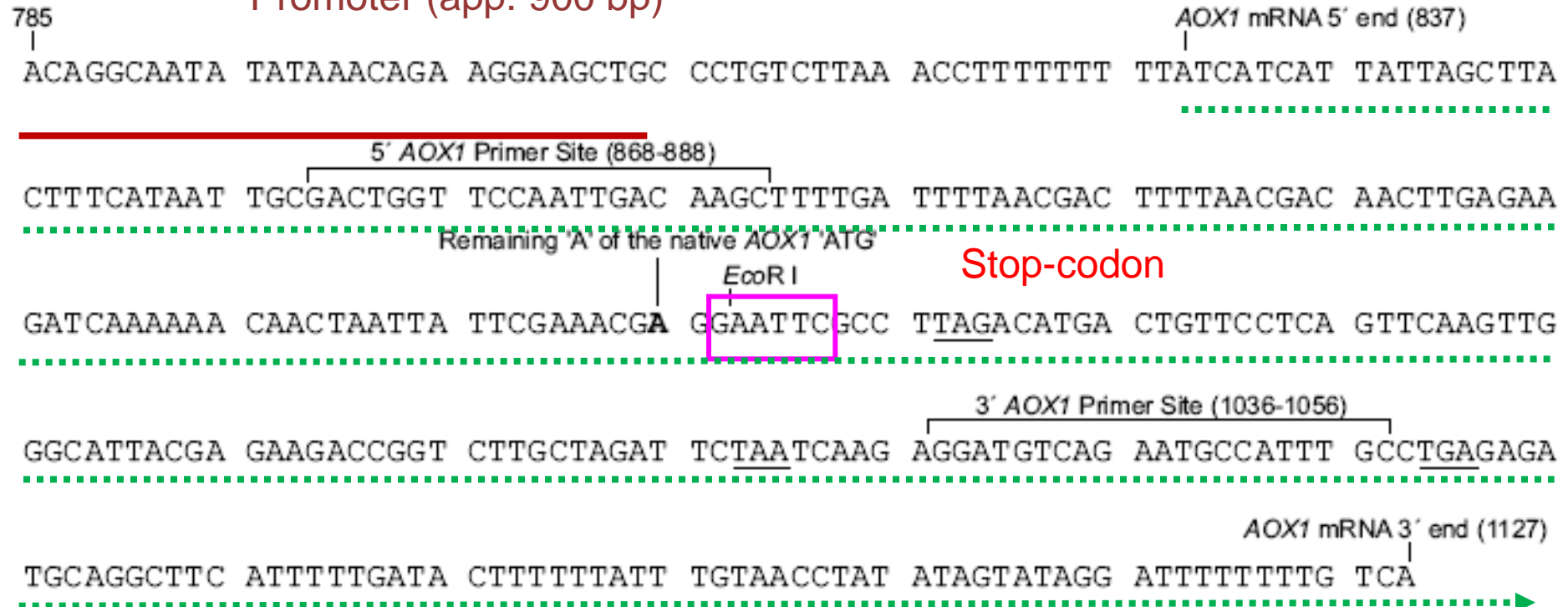

- For pHIL-D2, the fragment containing the gene of interest should have a Kozak consensus sequence for proper translation initiation, although this requirement is not as stringent in yeast. For example, ACC ATG G is a Kozak consensus sequence, where the ATG corresponds to the initiating ATG for your gene of interest (Cavener and Stuart, 1991; Kozak, 1987; Kozak, 1990).
- Shorter, 5' untranslated leaders reportedly work better in *AOX1* expression. In pHIL-D2, make the untranslated region as short as possible when cloning your gene.

mRNA

Vector for Secretory Expression

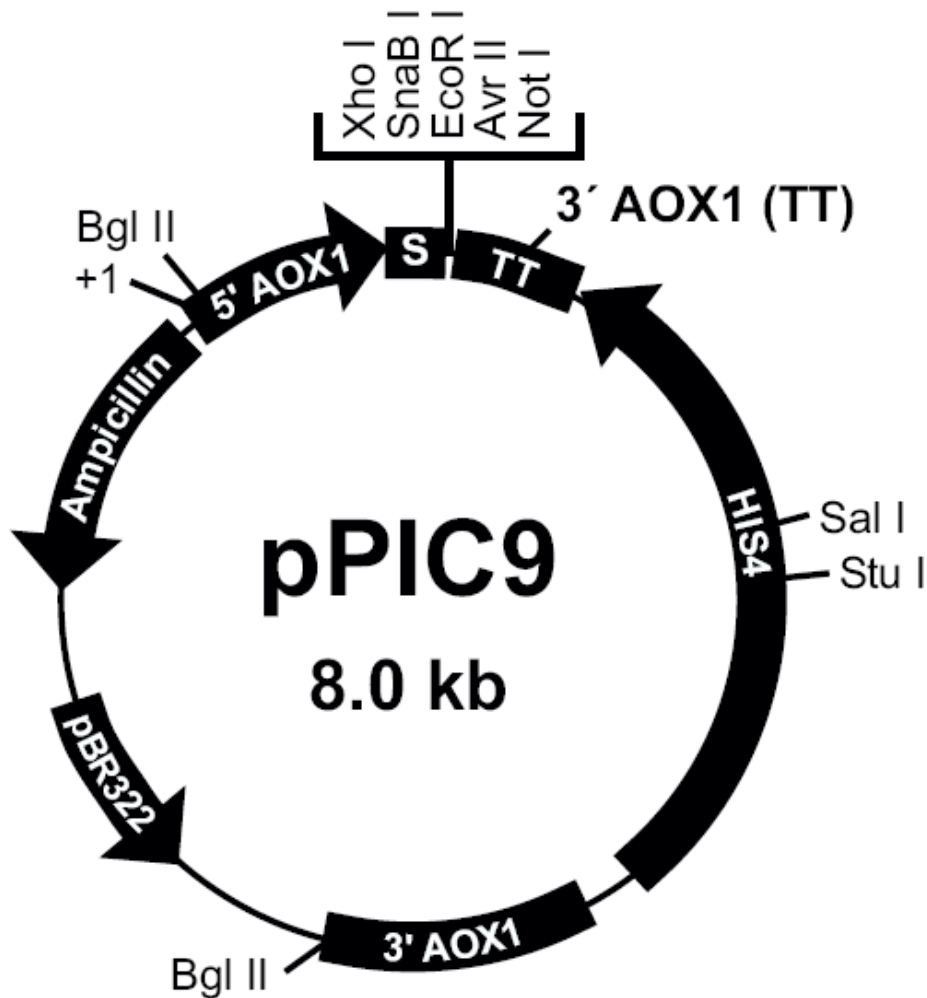

Comments for pPIC9: 8023 nucleotides

5' AOX1 promoter fragment: bases 1-948
 5' AOX1 primer site: bases 855-875
 α -Factor secretion signal(s): bases 949-1215
 α -Factor primer site: bases 1152-1172
 Multiple Cloning Site: bases 1192-1241
 3' AOX1 primer site: bases 1327-1347
 3' AOX1 transcription
 termination (TT): bases 1253-1586
 HIS4 ORF: bases 4514-1980
 3' AOX1 fragment: bases 4870-5626
 pBR322 origin: bases 6708-6034
 Ampicillin resistance gene: bases 7713-6853

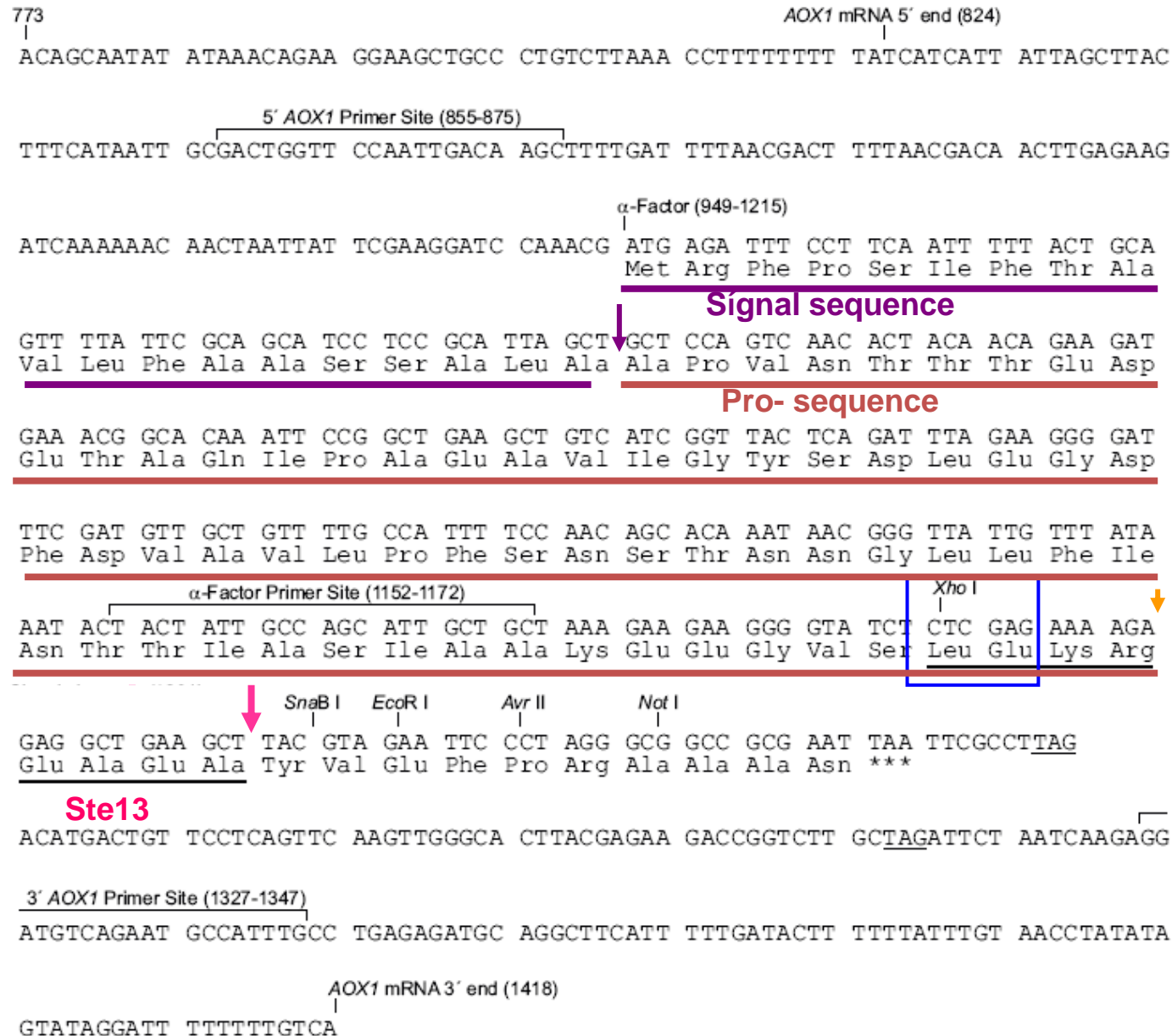

Resistance selection in *Pichia pastoris*, multiple integration and secretion

- P_{GAP}
- *AOX1* TT
- Zeo^R
- C-myc Epitope
- 6xHis
- alpha-factor
- ColE1 ori
- Multicopy Integration
“in vivo”

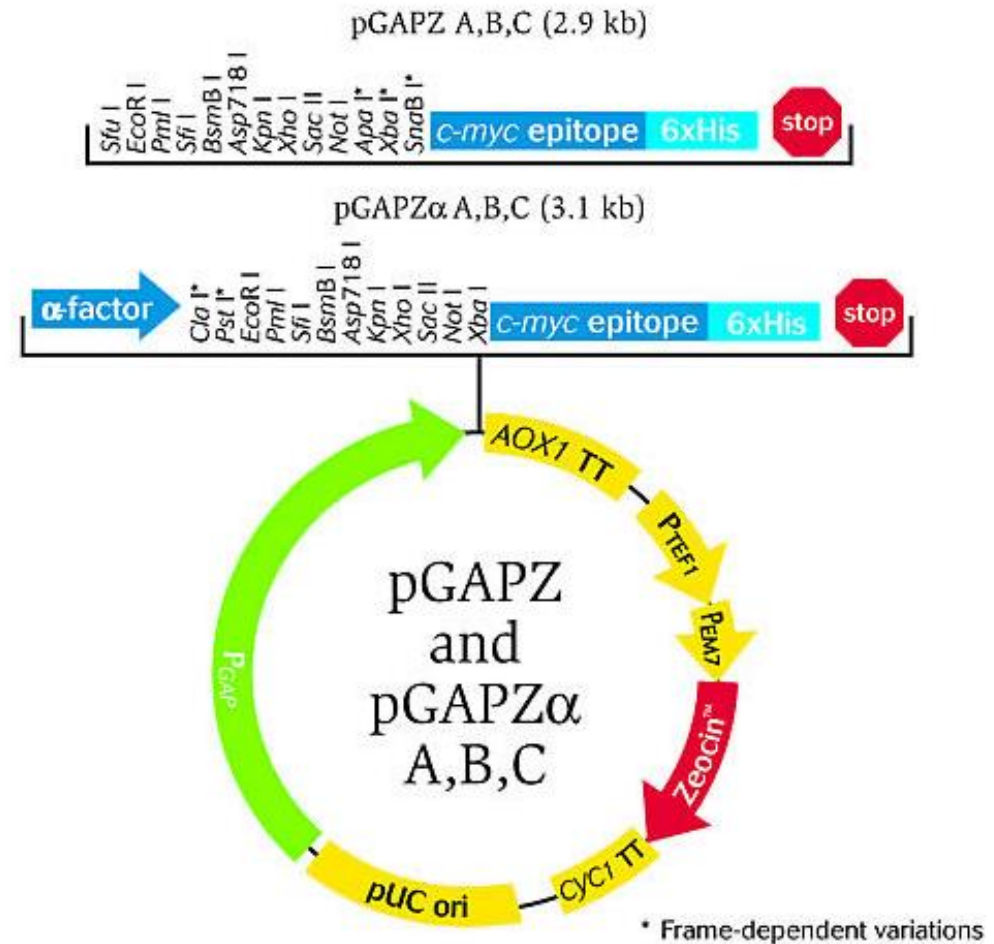

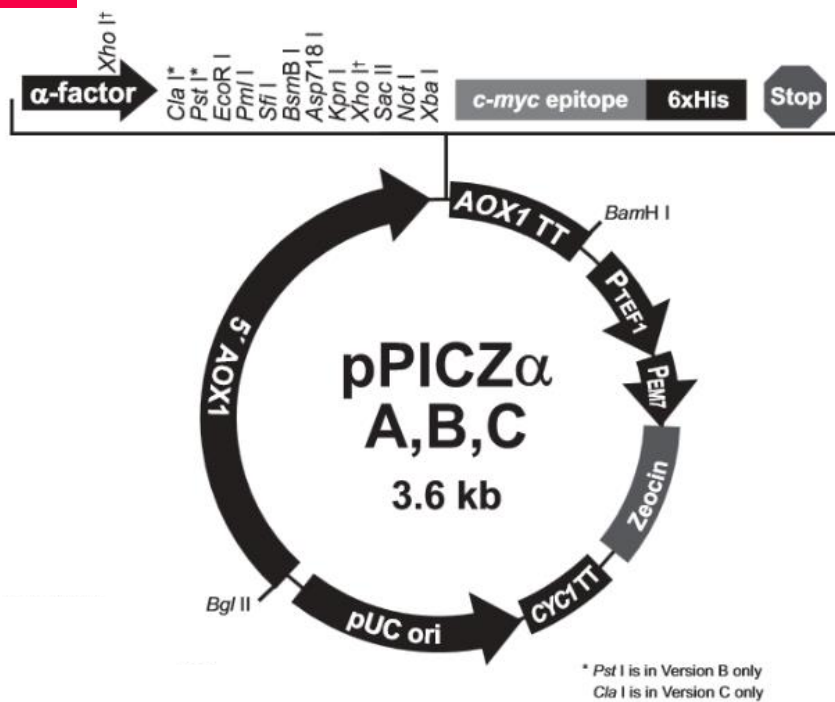

5' AOX1 promoter region: bases 1-941
 5' AOX1 priming site: bases 855-875
 α -factor signal sequence: bases 941-1207
 Multiple cloning site: bases 1208-1276
c-myc epitope: bases 1275-1304
 Polyhistidine (6xHis) tag: bases 1320-1337
 3' AOX1 priming site: bases 1423-1443
 AOX1 transcription termination region: bases 1341-1682
 TEF1 promoter: bases 1683-2093
 EM7 promoter: bases 2095-2162
Sh ble ORF: bases 2163-2537
 CYC1 transcription termination region: bases 2538-2855
 pUC origin: bases 2866-3539 (complementary strand)

Feature	Benefit
5' AOX1 promoter	A 942 bp fragment containing the AOX1 promoter that allows methanol-inducible, high-level expression of the gene of interest in <i>Pichia</i> . Targets plasmid integration to the AOX1 locus.
α -factor secretion signal (from <i>Saccharomyces cerevisiae</i>)	Allows for efficient secretion of most proteins from <i>Pichia</i> .
Multiple cloning site	Allows insertion of your gene into the expression vector.
<i>c-myc</i> epitope (Glu-Gln-Lys-Leu-Ile-Ser-Glu-Glu-Asp-Leu)	Permits detection of your recombinant fusion protein with the Anti- <i>myc</i> Antibody or Anti- <i>myc</i> -HRP Antibody (Evans <i>et al.</i> , 1985). See page viii for ordering information.
C-terminal polyhistidine (6xHis) tag	Permits purification of your recombinant fusion protein on metal-chelating resin such as ProBond™. In addition, the C-terminal polyhistidine tag is the epitope for the Anti-His(C-term) Antibody (Lindner <i>et al.</i> , 1997) and the Anti-His(C-term)-HRP Antibody. See page viii for ordering information.
AOX1 transcription termination (TT) region	Native transcription termination and polyadenylation signal from AOX1 gene (~260 bp) that permits efficient 3' mRNA processing, including polyadenylation, for increased mRNA stability.
TEF1 promoter (GenBank accession nos. D12478, D01130)	Transcription elongation factor 1 gene promoter from <i>Saccharomyces cerevisiae</i> that drives expression of the Zeocin™ resistance gene in <i>Pichia</i> .
EM7 promoter	Synthetic prokaryotic promoter that drives constitutive expression of the Zeocin™ resistance gene in <i>E. coli</i> .
Zeocin™ resistance gene (<i>Sh ble</i>)	Allows selection of transformants in <i>E. coli</i> and <i>Pichia</i> .
CYC1 transcription termination region (GenBank accession no. M34014)	3' end of the <i>Saccharomyces cerevisiae</i> CYC1 gene that allows efficient 3' mRNA processing of the Zeocin™ resistance gene for increased stability.
pUC origin	Allows replication and maintenance of the plasmid in <i>E. coli</i> .

Zeocin

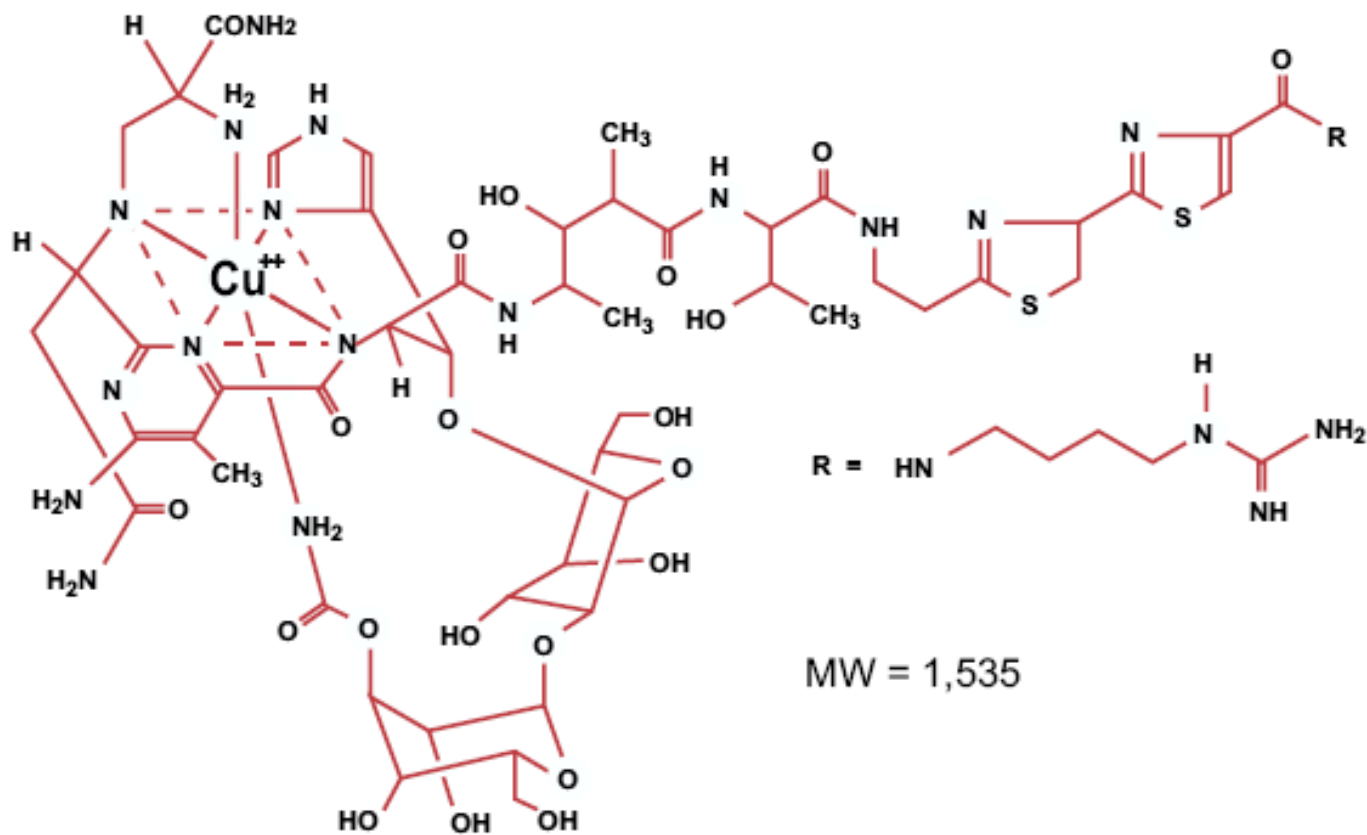

P.pastoris vectors for intracellular expression

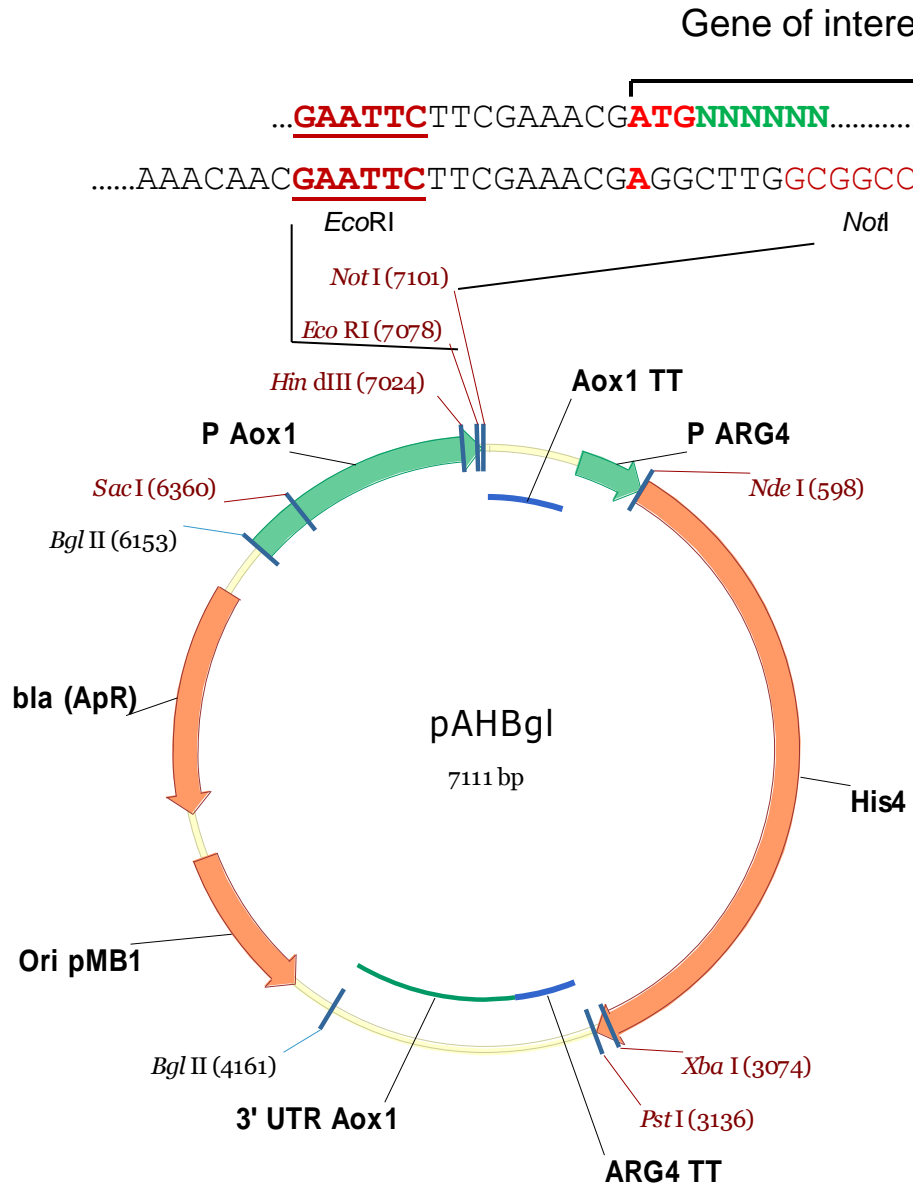

p A H Bgl

Promoter:	A → AOX1
Selection Marker:	H → HIS4 Z → Zeocin ^R A → ARG4 K → Kanamycin ^R
Restriction site:	Bgl → BglII Sph → SphI Swa → SwaI

P.pastoris vectors for secretory expression

Kex2 processing signal

Gene of interest

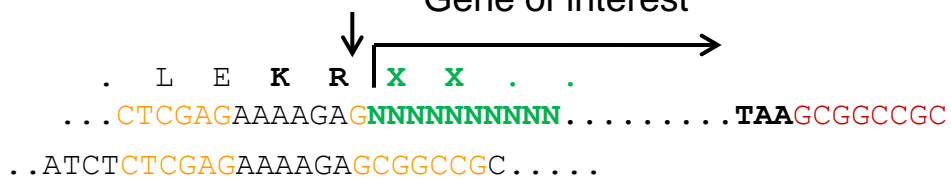

p A a H Bgl

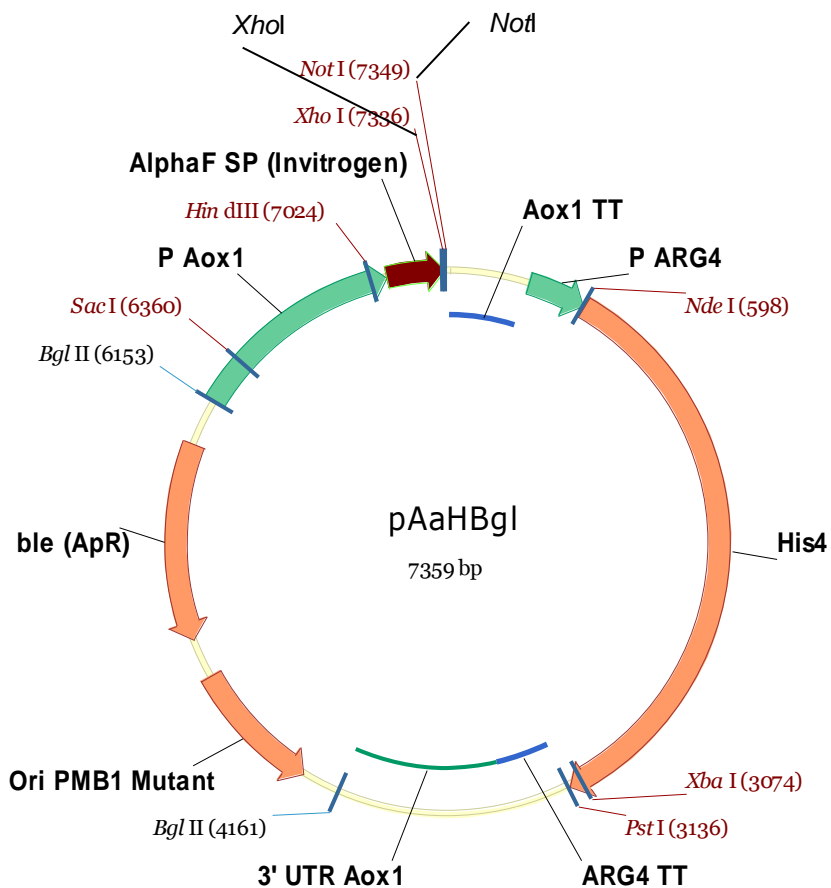

- | |
|---|
| <p>Promoter:
A → AOX1</p> |
| <p>Secretion Signal:
a → alpha factor</p> |
| <p>Selection Marker:
H → HIS4
Z → Zeocin^R
A → ARG4
K → Kanamycin^R</p> |
| <p>Restriction site:
Bgl → BglII
Sph → SphI
Swa → SwaI</p> |

Vectors for multiple Integrations

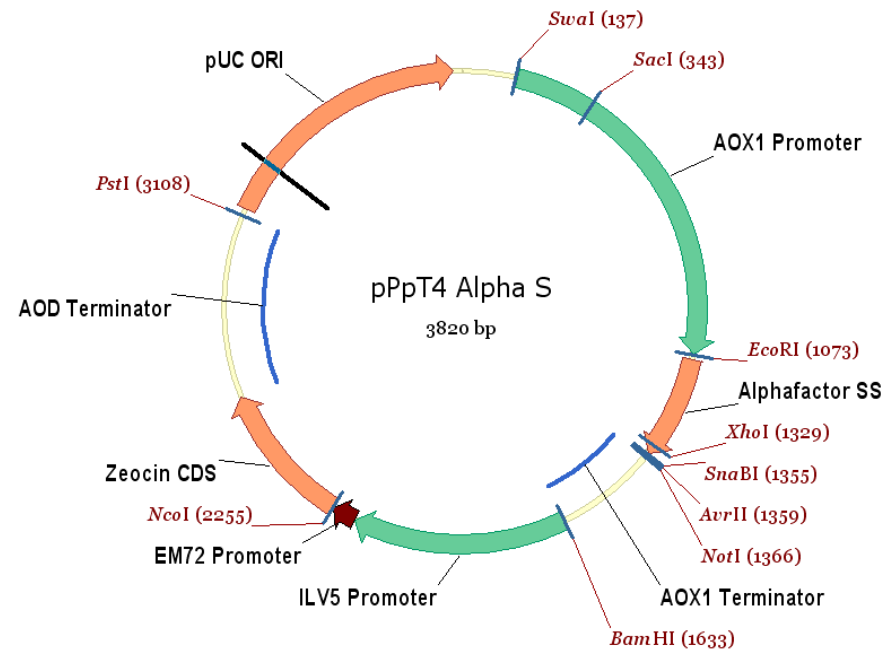

secretory

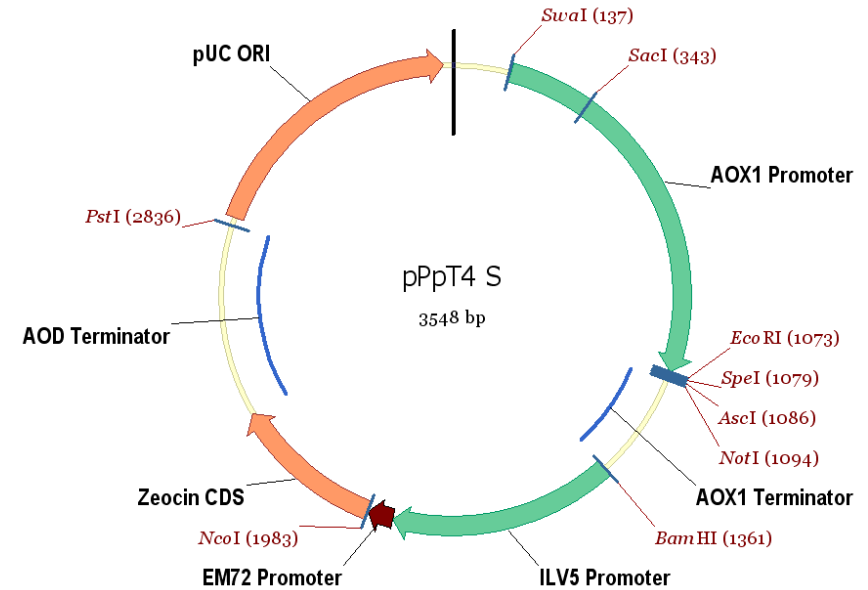

intracellular

Protein expressed	Expression Level (mg/L)	Reference
Bacterial proteins		
Tetanus toxin fragment C	12,000	Clare, J.J. <i>et al.</i> (1991) <i>Bio/Technology</i> 9: 455–460
α -amylase	2,500	Paifer, E. <i>et al.</i> (1994) <i>Yeast</i> 10: 1415–1419
T2A peroxidase	2,470	Thomas, L. <i>et al.</i> (1998) <i>Can. J. Microbiol.</i> 44: 364–372
<i>C. botulinum</i> neurotoxin fragment	78	Smith, L.A. (1998) <i>Toxicon</i> 36: 1539–1548
Yeast proteins		
Catalase L	2,300	Calera, J.A. <i>et al.</i> (1997) <i>Infect. Immun.</i> 65: 4718–4724
Glucoamylase	400	Fierobe, H.-P. <i>et al.</i> (1997) <i>Protein Expr. Purif.</i> 9: 159–170
Lipase	60	Minning, S. <i>et al.</i> (1998) <i>J. Biotechnol.</i> 66: 147–156
Plant proteins		
Hydroxynitrile lyase	22,000	Hasslacher, M. <i>et al.</i> (1997) <i>Protein Expr. Purif.</i> 11: 61–71
Wheat lipid transfer protein	720	Klein, C. <i>et al.</i> (1998) <i>Protein Expr. Purif.</i> 13: 73–82
Aeroallergen	60	Huecas, S. <i>et al.</i> (1999) <i>Eur. J. Biochem.</i> 261: 539–546.
Invertebrate proteins		
Hirudin	1,500	Rosenfeld, S.A. <i>et al.</i> (1996) <i>Protein Expr. Purif.</i> 8: 476–482.
Spider dragline silk protein	663	Fahnestock, S.R. <i>et al.</i> (1997) <i>Appl. Micro. Biotechnol.</i> 47: 33–39
Honeybee olfactory protein	200	Danty, E. <i>et al.</i> (1999) <i>J. Neuroscience</i> 19: 7468–7475
Mammalian proteins		
Mouse gelatin	14,800	Werten, M.W. <i>et al.</i> (1999) <i>Yeast</i> 15: 1087–1096
Porcine carboxypeptidase B	200	Ventura, S. <i>et al.</i> (1999) <i>J. Biol. Chem.</i> 274: 19925–33
Human tumor necrosis factor	10,000	Sreekrishna, K. <i>et al.</i> (1989) <i>Biochemistry</i> 28: 4117–4125
Human IGF-1	600	Brierley, R.A. (1998) <i>Methods Mol. Biol.</i> 103: 149–177
Human CD38	455	Munshi, C.B. (1997) <i>Methods Enzymol.</i> 280: 318–330
15N-Interferon τ	10	Johnson, T.M. <i>et al.</i> (1999) <i>J. Interferon Cytokine Res.</i> 19: 631–636

Baculovirus Expression system

Autographa californica nuclear polyhedrosis virus (AcNPV)

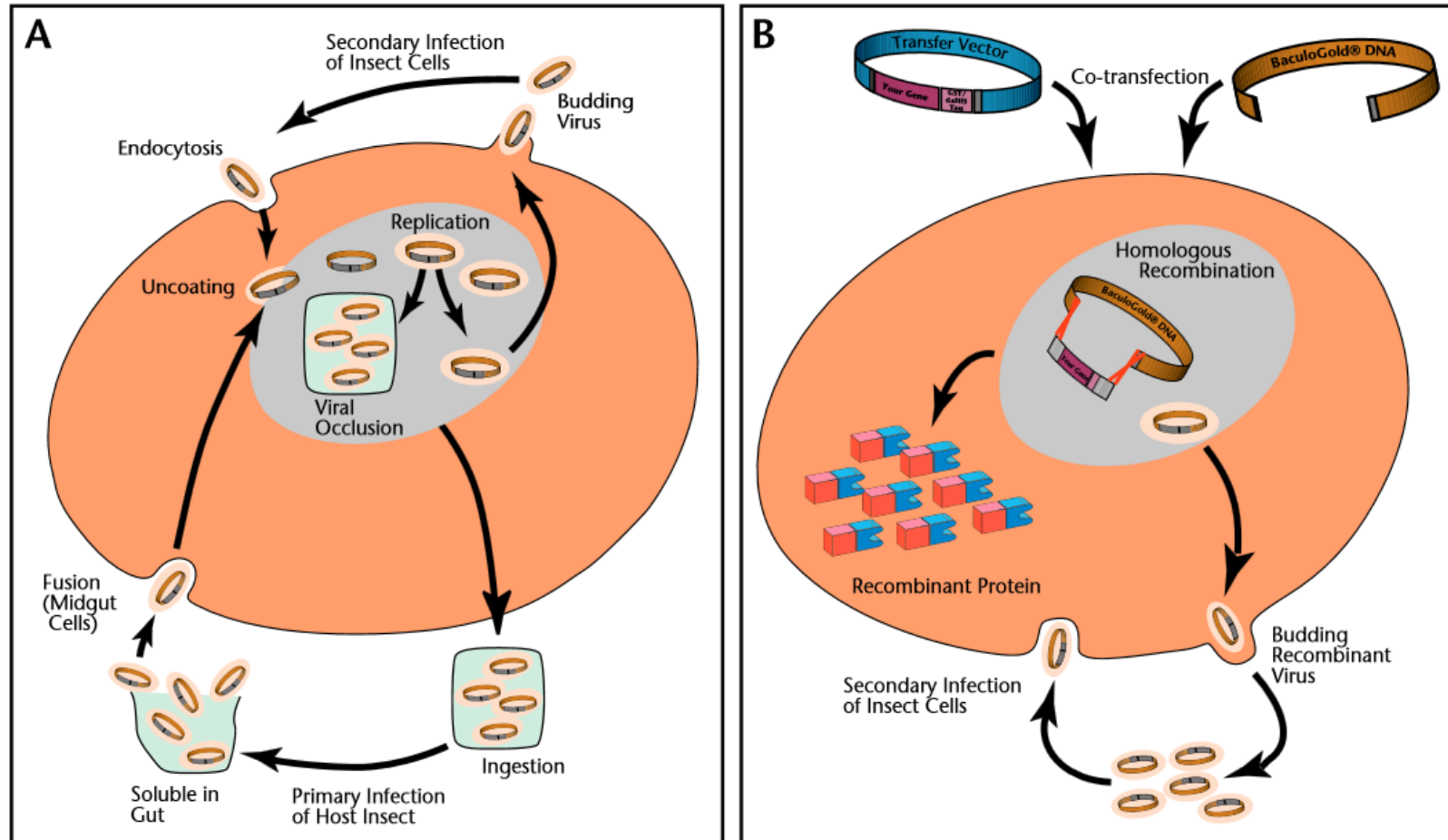

Heterologous genes are cloned into transfer vectors

Co-transfection of the transfer vector and AcNPV DNA into *Spodoptera frugiperda* (Sf) cells → recombination between homologous sites

Baculovirus Expression System

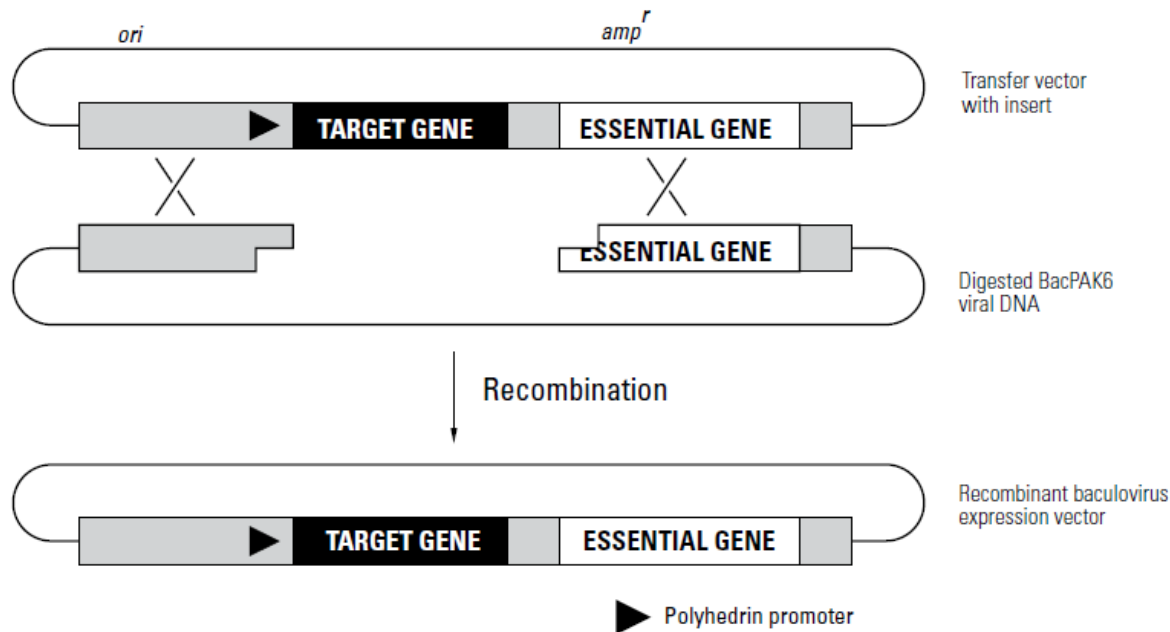

Transfer Vector

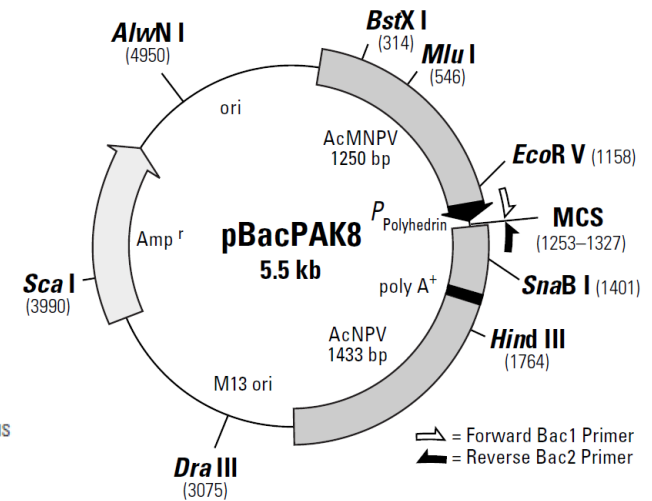

Transfer of a target gene to the Baculovirus expression vector by forced recombination between a transfer vector and BacPAK6 viral DNA.

FIGURE 7.18 Production of recombinant baculovirus. Single Bsu36I sites are engineered into gene 603 and a gene (1629) that is essential for AcMNPV replication. These genes flank the polyhedrin gene in the AcMNPV genome. After a baculovirus with two engineered Bsu36I sites is treated with Bsu36I, the segment between the Bsu36I sites is deleted. Insect cells are cotransfected with a Bsu36I-treated baculovirus DNA and a transfer vector with a gene of interest under the control of the promoter (*p*) and terminator (*t*) elements of the polyhedrin gene and the complete sequences of both genes 603 and 1629. A double crossover event (dashed lines) generates a recombinant baculovirus with a functional gene 1629. With this system, almost all of the progeny baculoviruses are recombinant.

Baculovirus Expression System

Modified baculovirus

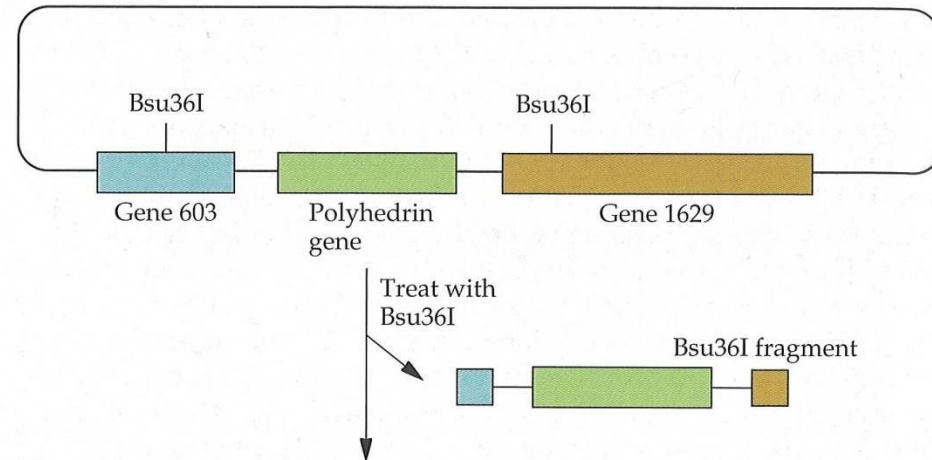

Cleaved baculovirus

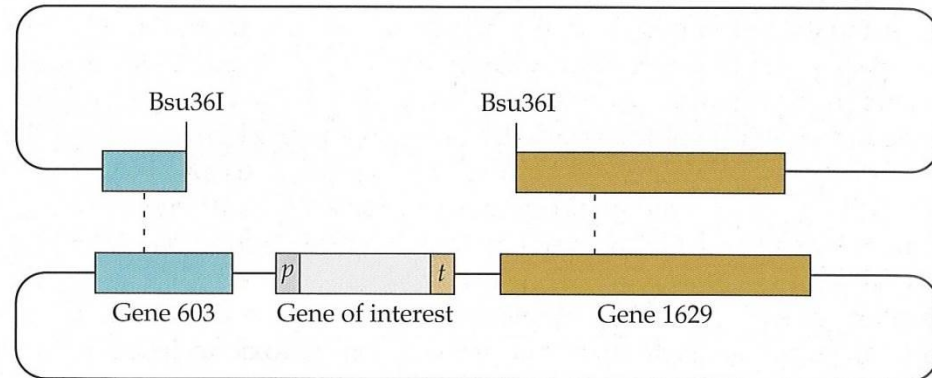

Transfer vector

Recombinant baculovirus

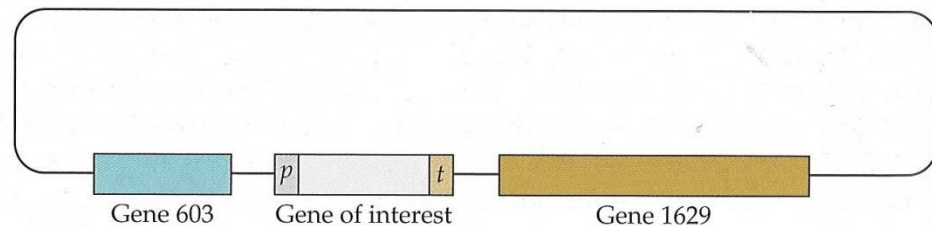

Baculovirus Expression System

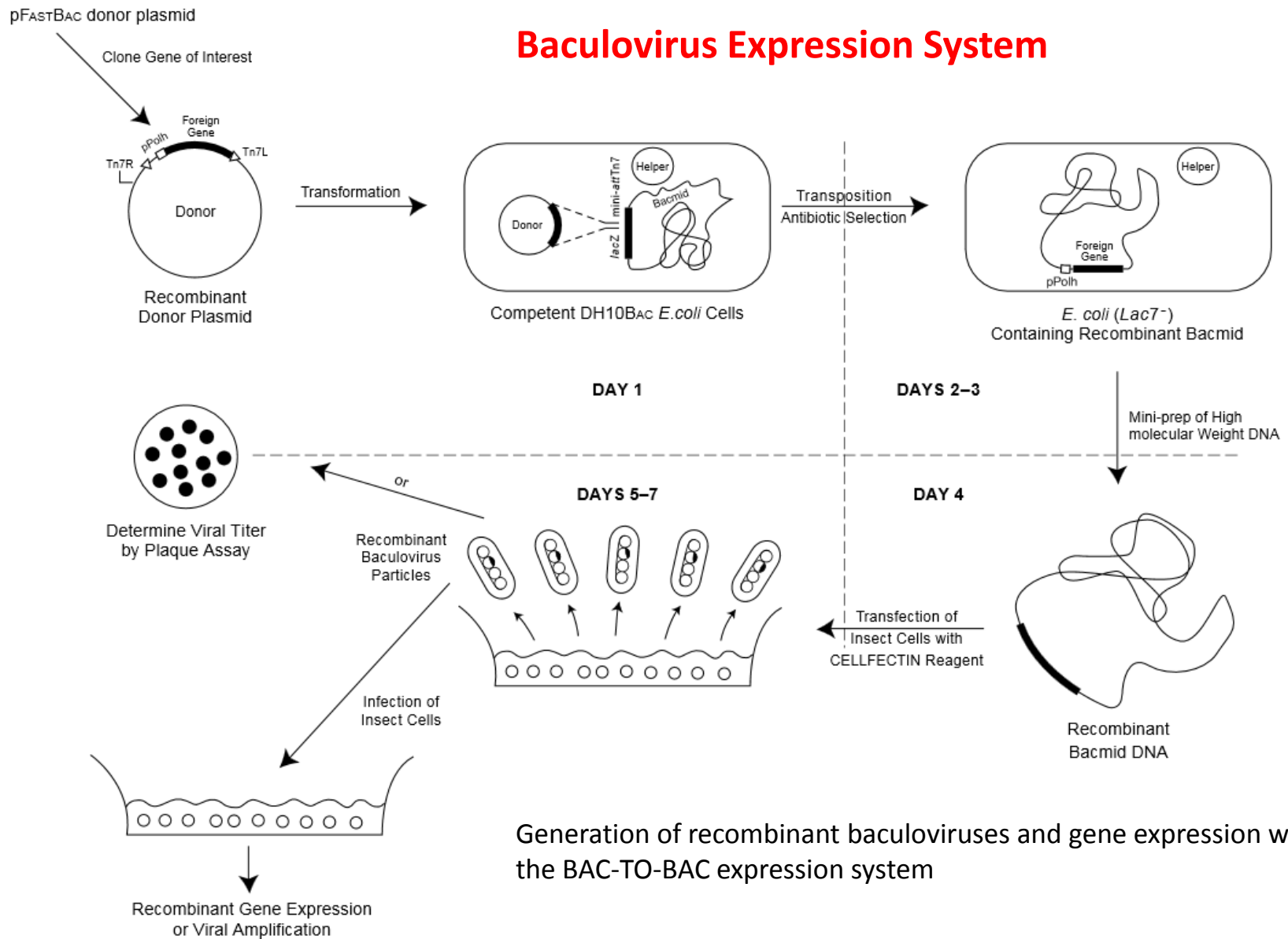

Generation of recombinant baculoviruses and gene expression with the BAC-TO-BAC expression system

Mammalian Expression System

Expression signals

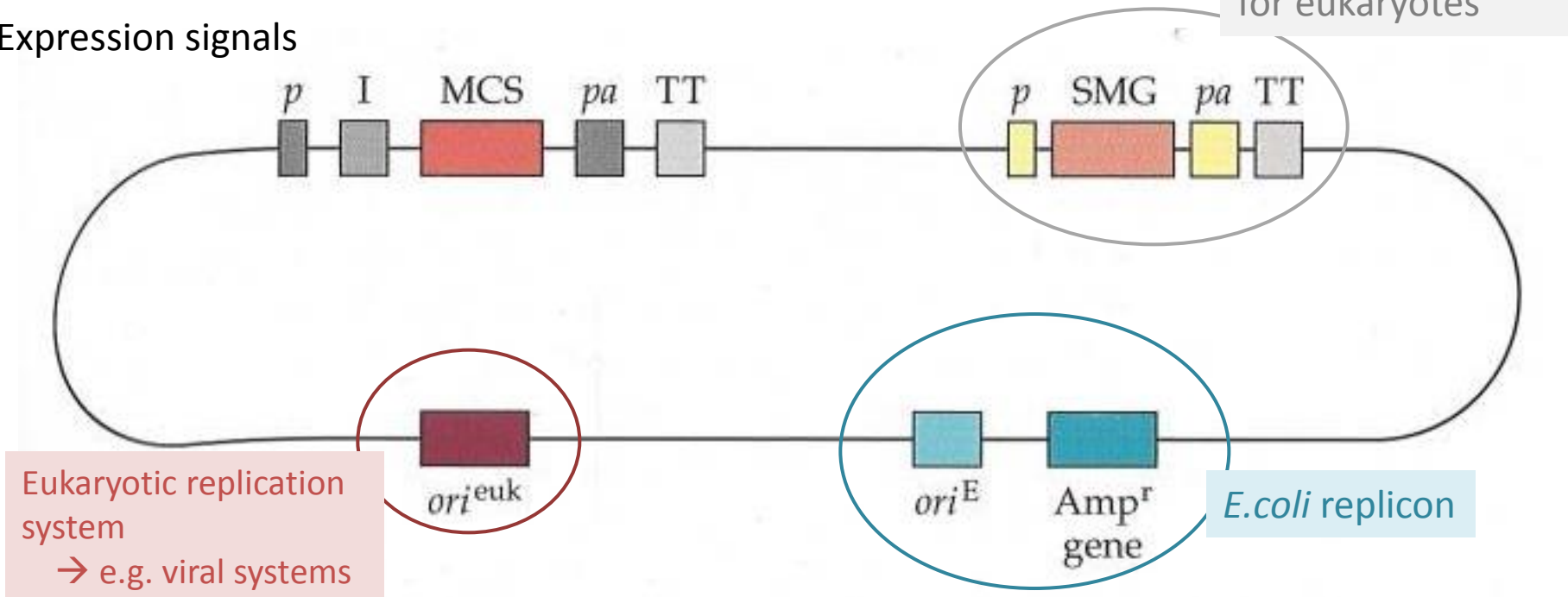

FIGURE 7.23 Generalized mammalian expression vector. The multiple cloning site (MCS) and selectable marker gene (SMG) are under the control of eukaryotic promoter (*p*), polyadenylation (*pa*), and termination of transcription (TT) sequences. An intron (I) enhances the production of heterologous protein. Propagation of the vector in *E. coli* and mammalian cells depends on the origins of replication *ori*^E and *ori*^{euk}, respectively. The ampicillin resistance (*Amp*^r) gene is used for selecting transformed *E. coli*.

Expression strategies for mammals

Selection needed in order to find clones positioned at transcription-active sites

DHFR:

Selection for high expression with methotrexate

→ Increased resistance to methotrexate: high probability of high expression of targeted protein

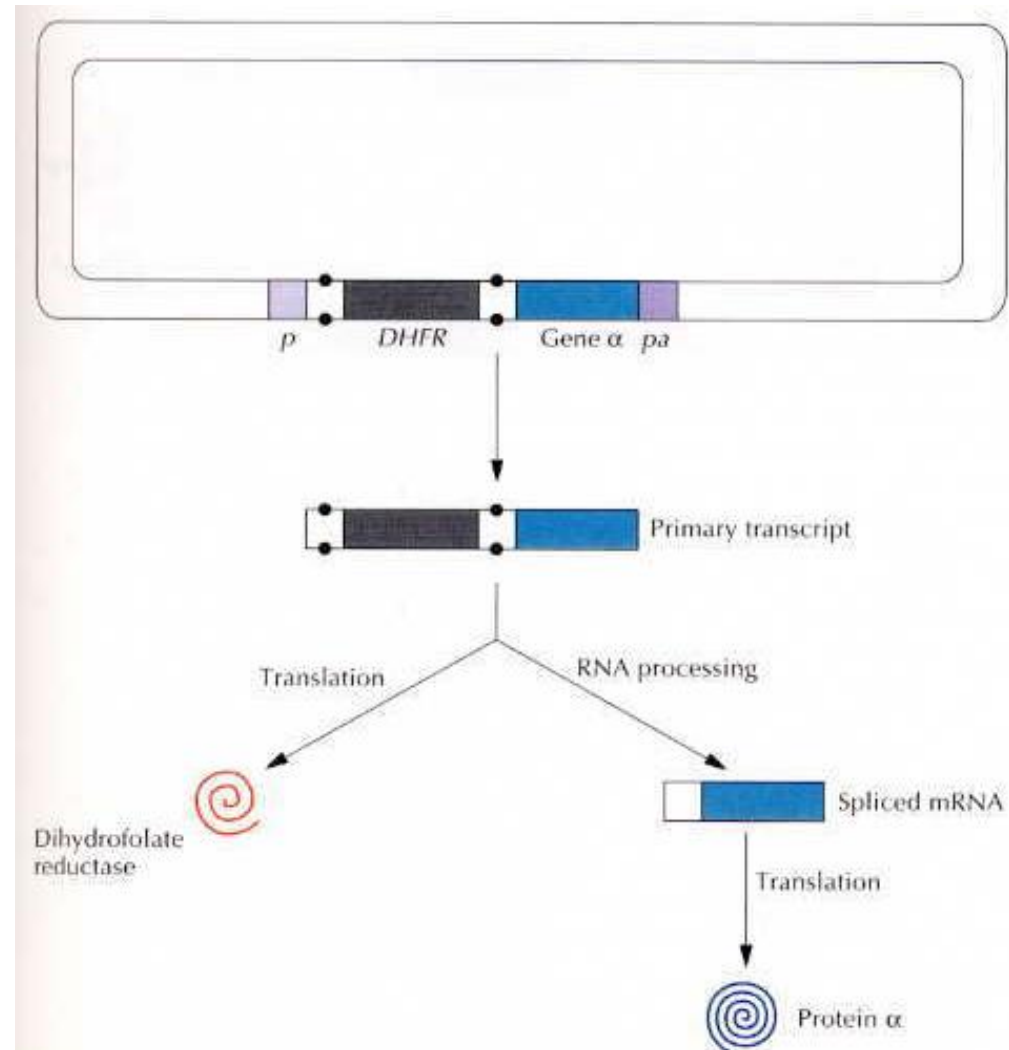
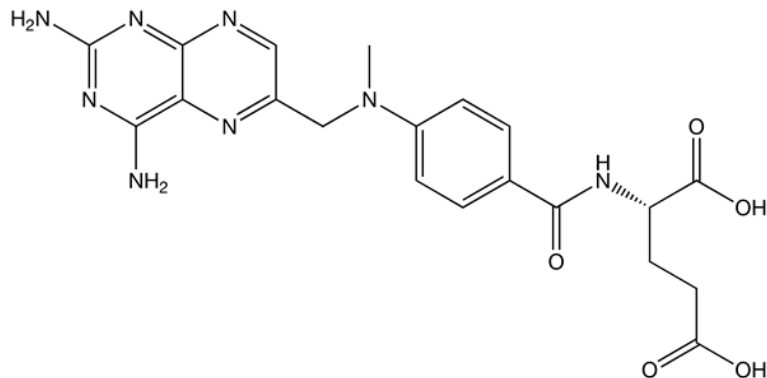
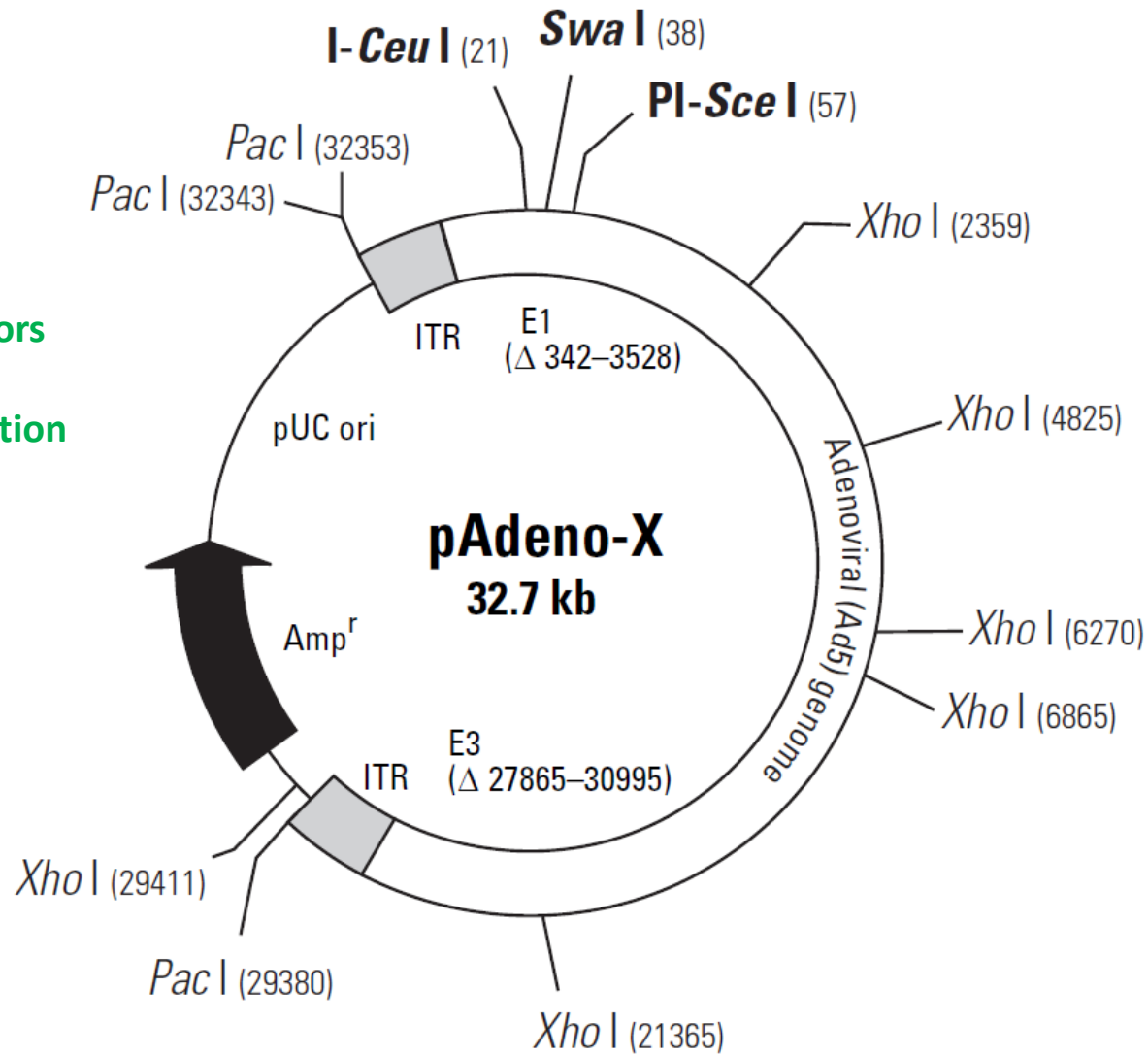

Figure 7.14 Coordinated expression of DHFR and a recombinant protein. A DHFR gene is cloned between intron donor and acceptor splice sites (dots) and upstream from a cloned gene (gene α). Both the DHFR and cloned genes are under the control of eukaryotic promoter (p) and polyadenylation (pa) sequences. Dihydrofolate reductase and the heterologous protein (protein α) are translated from the unspliced (primary) and processed (spliced) transcripts, respectively.

Mammalian Expression System

Adenovirus based Vectors

→ Autonomous replication
in mammalian cells



Mammalian Expression System

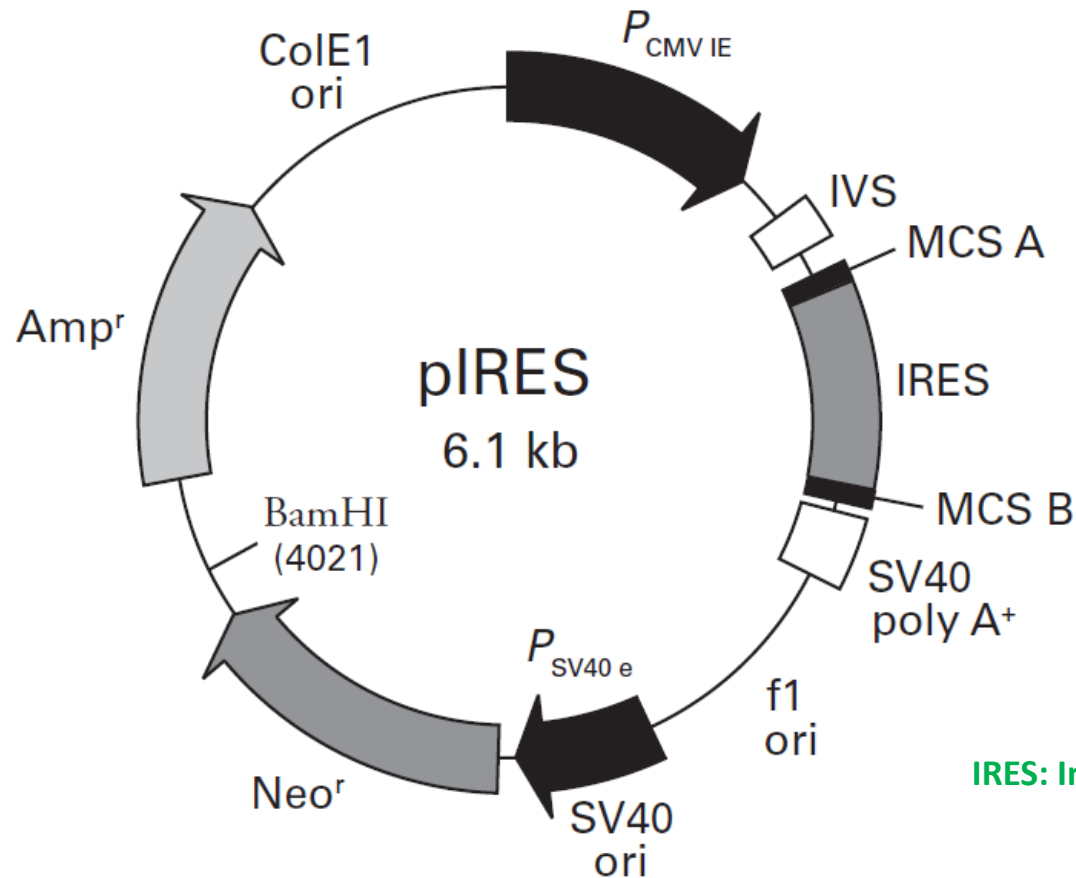

pIRES is a mammalian expression vector that allows high level expression of two genes of interest from the same bicistronic mRNA transcript. The vector contains the encephalomyocarditis virus (ECMV) internal ribosome entry site (IRES) flanked by two multiple cloning sites (MCS A and B), an arrangement that allows cap-independent translation of the gene cloned into MCS B (1–3). pIRES utilizes a partially disabled IRES sequence that reduces the rate at which the gene cloned into MCS B is translated relative to that of MCS A.

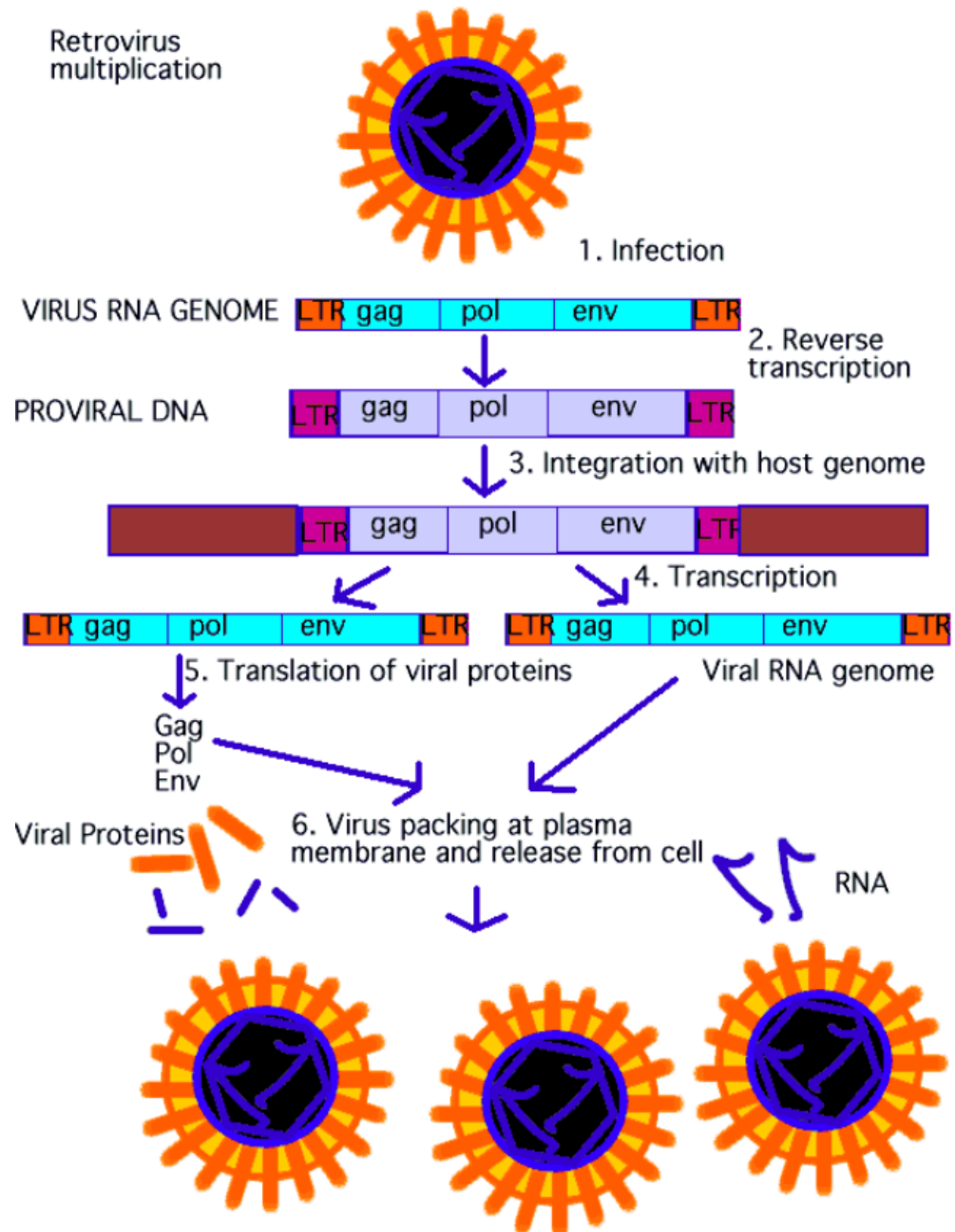
97 **Retroviral vectors**

Retroviral expression system

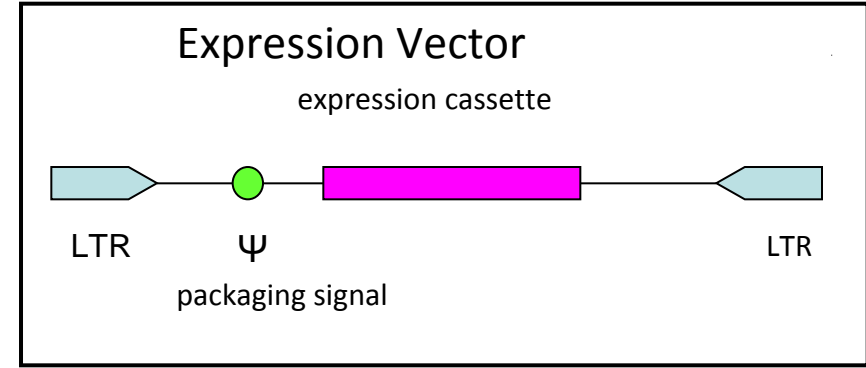
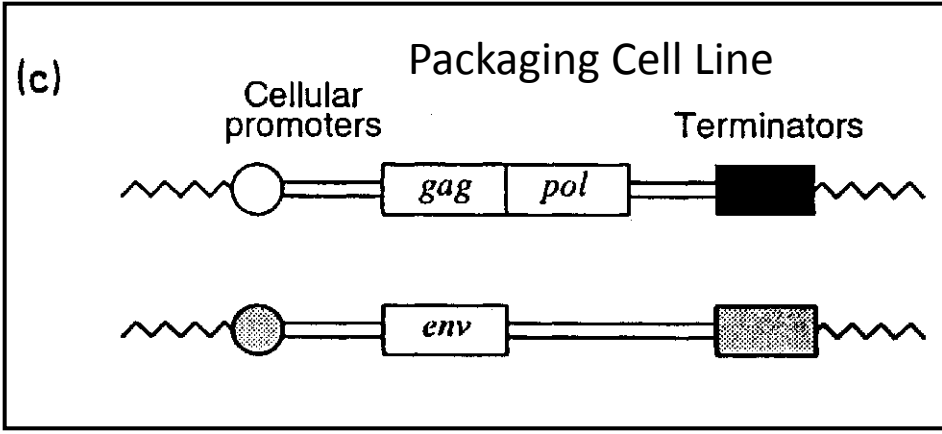
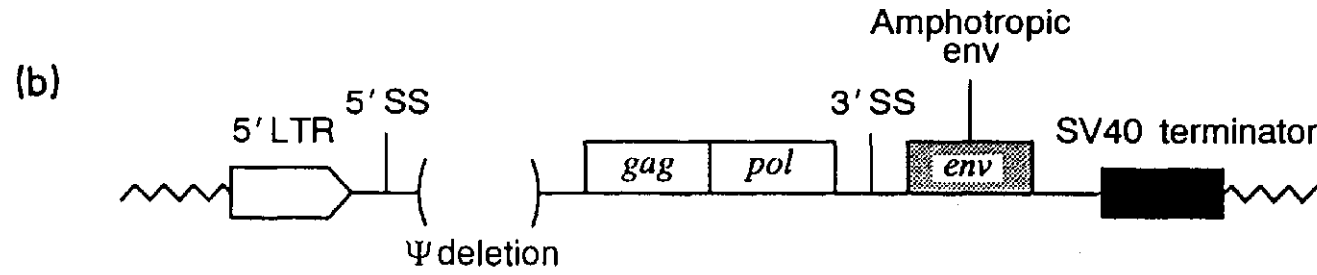
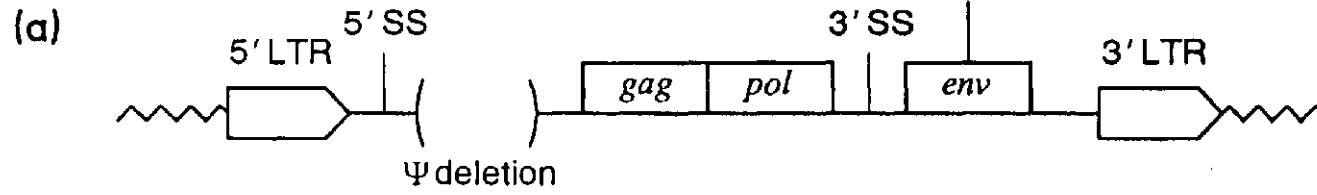

Recombinant retroviral genomes in packaging cell lines

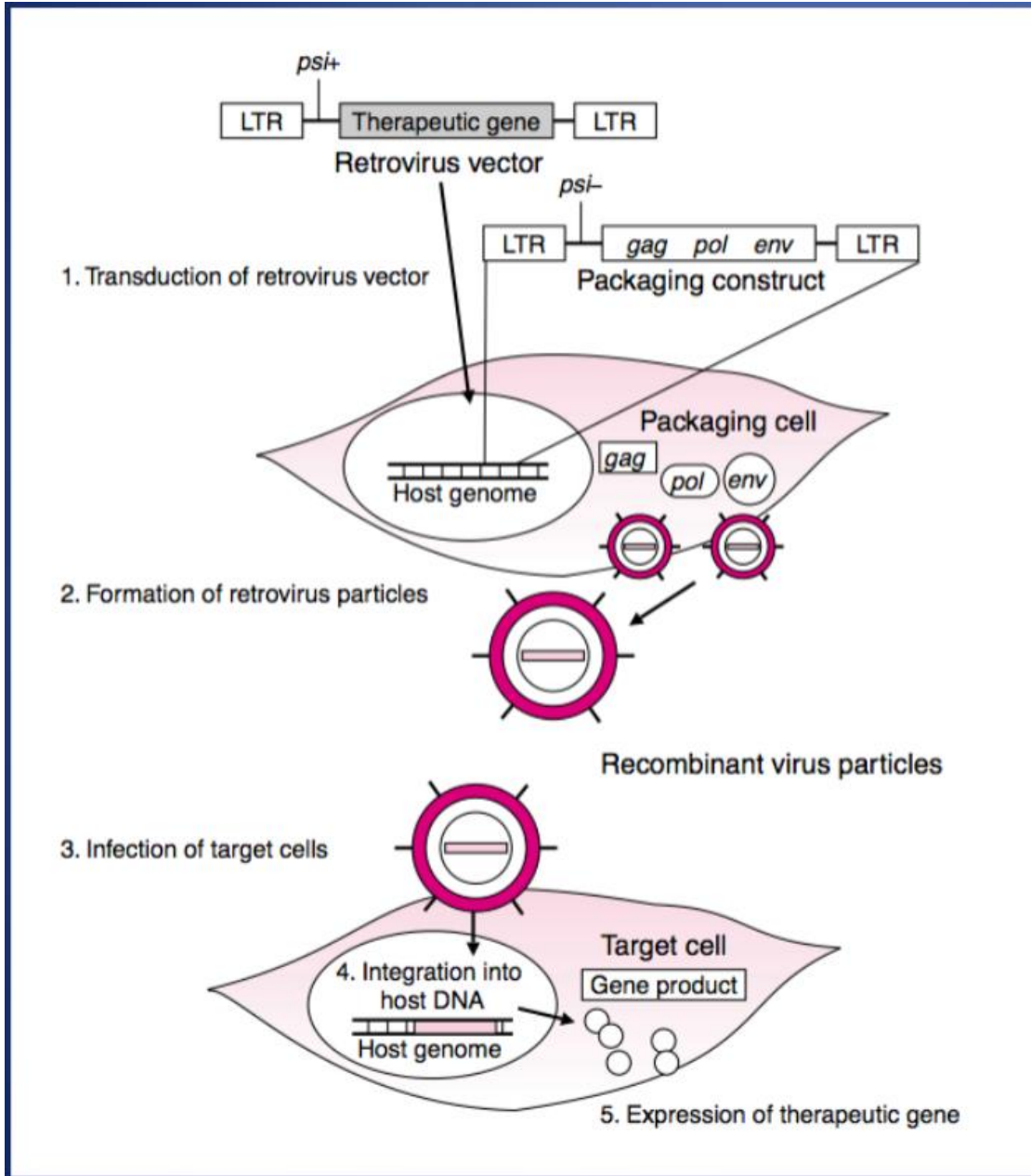

Recombinant Retroviruses

- Can be pseudotyped with various env proteins to broaden tropism
- Stable packaging cells
- Long-term gene expression through integration
- Downside is insertional mutagenesis
- Disadvantage is only infects dividing cells

Basic retrovirus vector

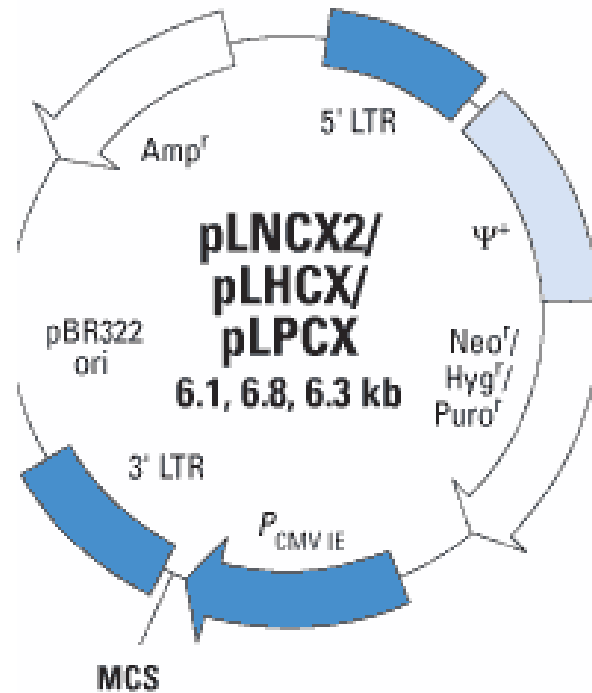

Schematic of LRCX Vectors

Packaging Cell

(produces viral proteins from stably integrated genes)

Virus production in packaging cell lines.

The *gag*, *pol* and *env* genes required for viral production are integrated into the packaging cells genome. The vector provides the viral packaging signal, commonly denoted Ψ^+ , a target gene, and drug-resistance marker.

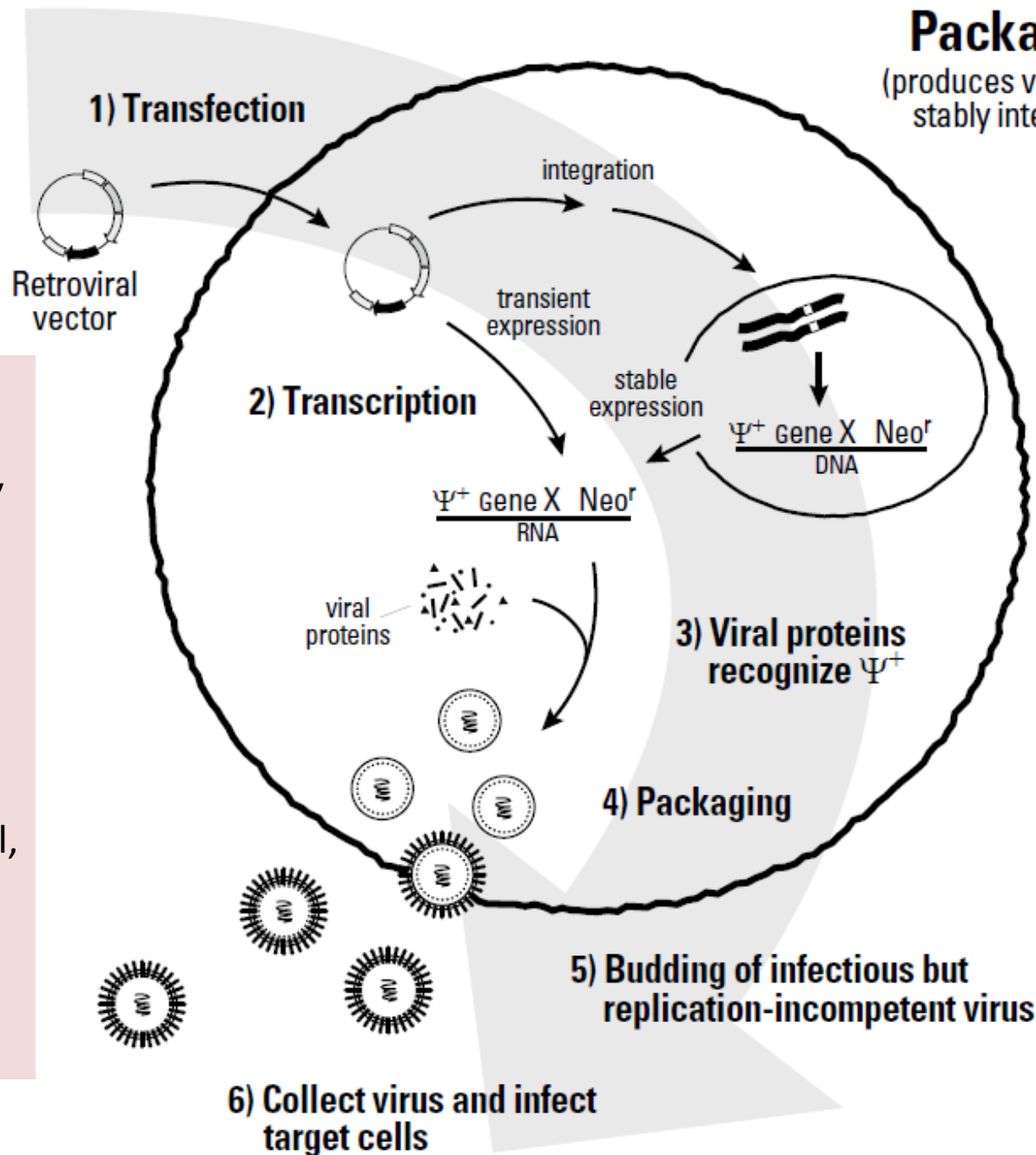

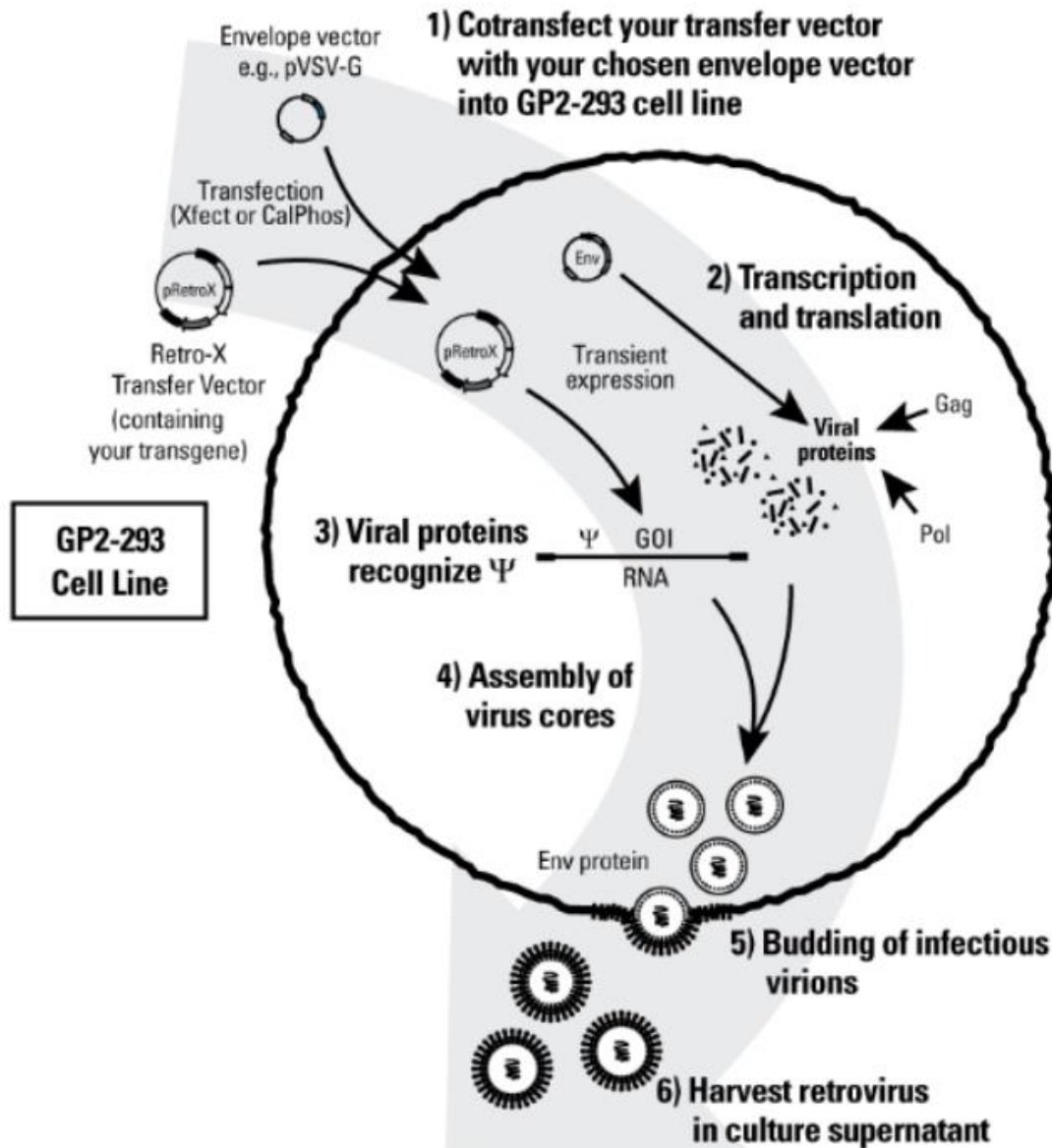

Step 1: Cotransfect GP2-293 cells with the Retro-X vector containing your gene of interest (GOI) and an envelope plasmid such as pVSV-G

Step 2: Resulting production of the corresponding recombinant retroviral genome and viral packaging proteins. GP2-293 Cells express gag and pol from genomic locations

Step 3: Recognition of the packaging sequence (Ψ) on the recombinant viral RNA genome by the packaging proteins.

Step 4: Resulting assembly of viral cores, which are transported to the cell membrane.

Step 5: Cores are then enveloped by cellular membrane containing aggregated VSV-G or other envelope proteins. Mature, infectious virions then bud from the cell.

Step 6: Infectious virions are collected in the medium.

NOTE: Although the virions are infectious, they lack several critical genes required for their subsequent replication and production in target cells. Separating the viral proteins and supplying them *in trans* adds a strong measure of safety to virus production, since several low-frequency recombination events would need to occur in order to regenerate a replication-competent viral genome.

Cell Line	GP2-293	Ampho-Pack-293	EcoPack 2-293	RetroPack PT67
Cat. Nos.	631530, 631512	631505	631507	631510
Cell line origin	HEK 293	HEK 293	HEK 293	NIH/3T3
Tropism	Pantropic, ecotropic, amphotropic, dualtropic	Amphotropic	Ecotropic	Dualtropic
Envelopes	VSV-G, amphi, eco, or 10A1	4170A (amphi)	gap70 (eco)	10A1
Target cells	Wide range of mammalian/non-mammalian cells	Wide range of mammalian cells	Mouse, rat cells	Wide range of mammalian cells

Envelope	VSV-G	4070A (Amphi)	gap70 (Eco)	10A1 (Dual)	
Tropism	Pantropic	Amphotropic	Ecotropic	Dualtropic	
Receptor (target cell)	Unknown ^b	RAM1 (Pit2)	mCAT-1	GALV (Pit1), RAM1 (Pit2)	
Possible target cell types^a	Human	+	+	-	+
	Mouse	+	+	+	+
	Rat	+	+	+	+
	Hamster	+	+/-	-	+
	Cat	+	+	-	+
	Dog	+	+	-	+
	Monkey	+	+	-	+
	Avian	+	-	-	-
	Fish	+	-	-	-
	Insect	+	-	-	-

Transient Production

Plate packaging cells

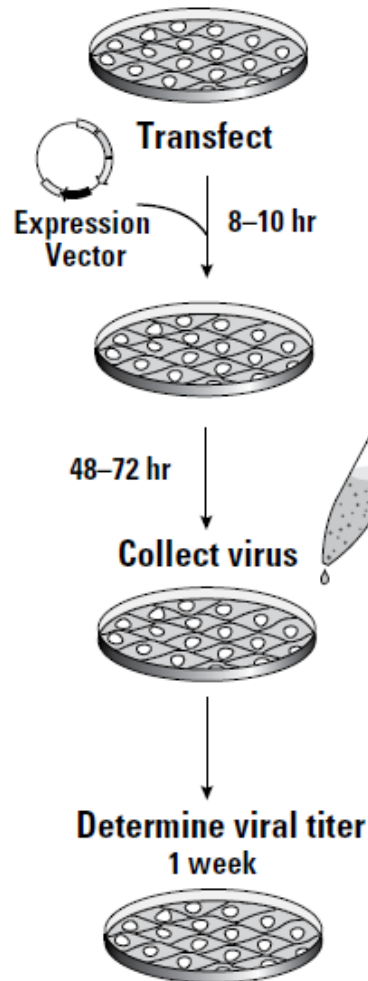

Target Cell Infection

Plate target cells

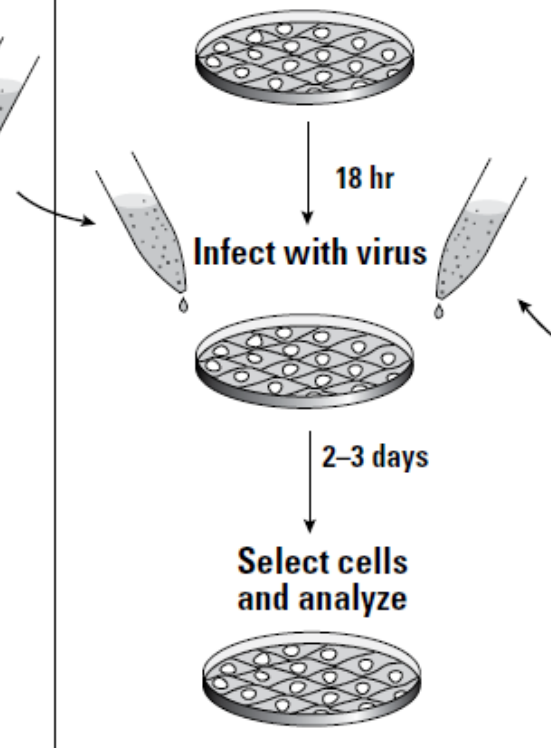

Stable Production

Plate packaging cells

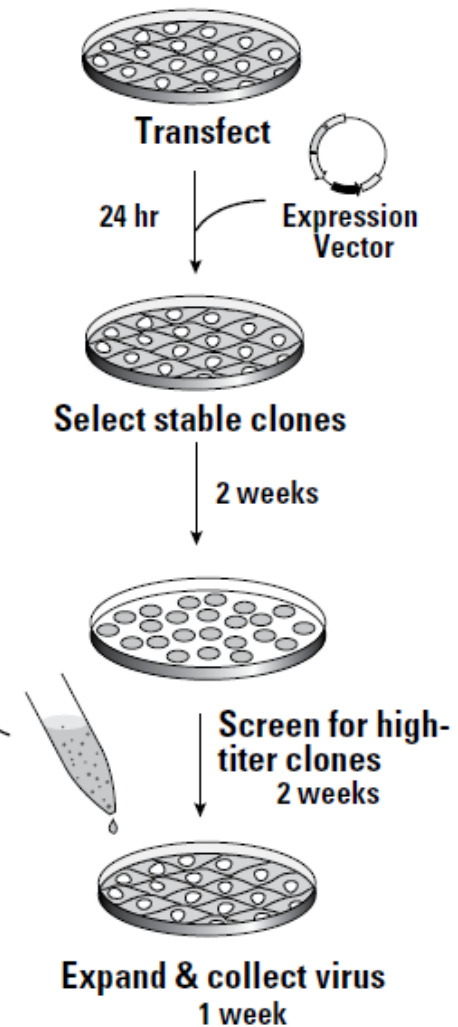

Select stable clones

2 weeks

Screen for high-titer clones
2 weeks

Expand & collect virus
1 week

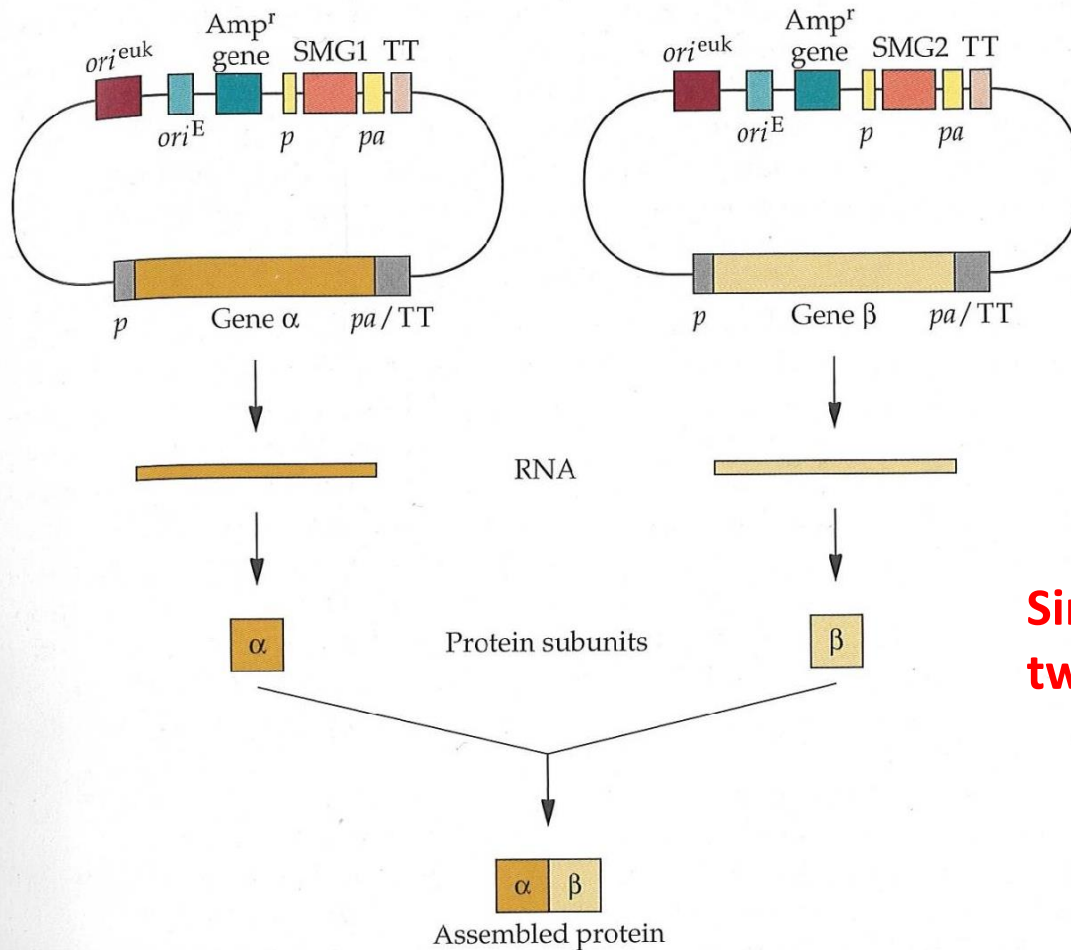

Simultaneous expression of two polypeptides

FIGURE 7.25 Two-vector expression system. The cloned genes (gene α and gene β) encode subunits of a protein dimer ($\alpha\beta$). After cotransfection, both subunits (α and β) are synthesized and assembled into a functional protein dimer. Both vectors carry origins of replication for *E. coli* (*ori^E*) and mammalian cells (*ori^{euk}*) and a marker (*Amp^r*) gene for selecting transformed *E. coli*. The selectable marker genes (*SMG1* and *SMG2*) and the cloned genes (gene α and gene β) are each under the control of promoter (*p*), polyadenylation (*pa*), and termination of transcription (*TT*) sequences.

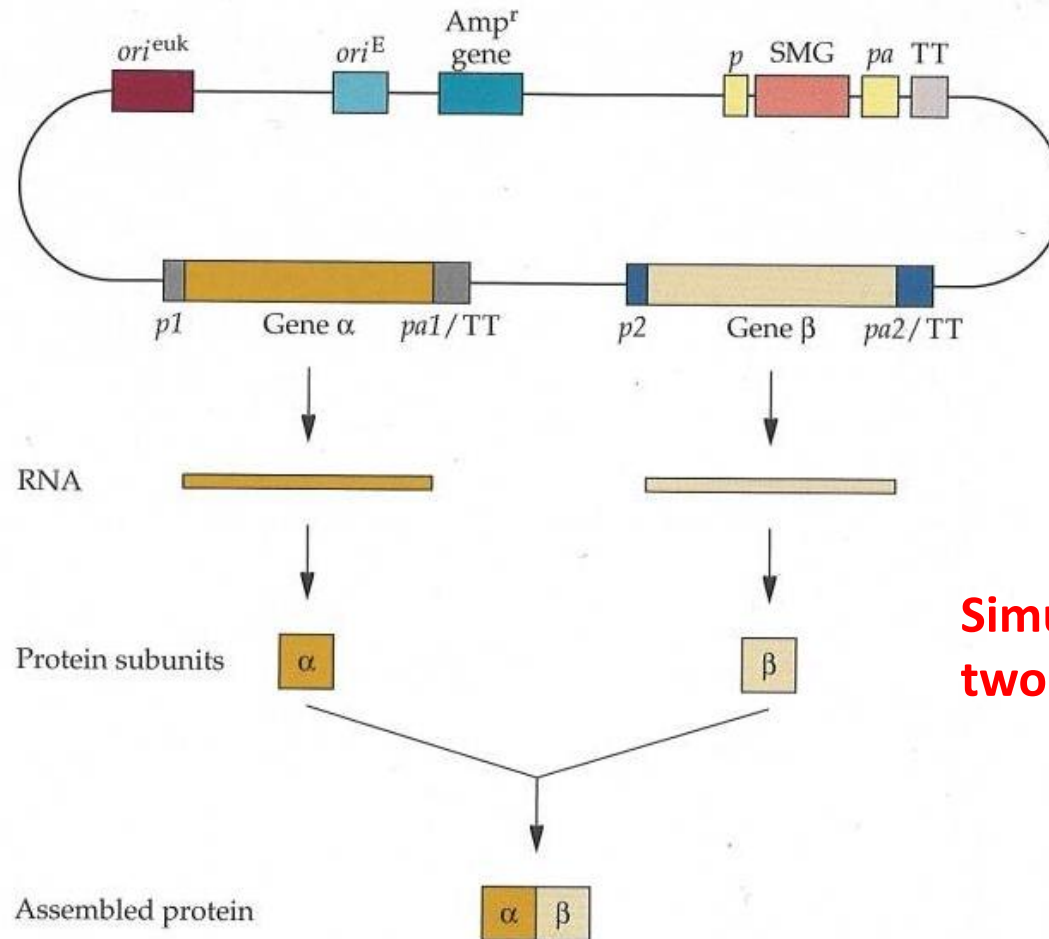

Simultaneous expression of two polypeptides

FIGURE 7.26 Two-gene expression vector. The cloned genes (gene α and gene β) encode subunits of a protein dimer ($\alpha\beta$). The cloned genes are inserted into a vector and are under the control of different eukaryotic promoter (*p*), polyadenylation (*pa*), and termination of transcription (TT) sequences. Each subunit is translated from a separate mRNA, and a functional protein dimer ($\alpha\beta$) is assembled. The vector has origins of replication for *E. coli* (*ori^E*) and mammalian cells (*ori^{euk}*), a marker gene (*Amp^r*) for selecting transformed *E. coli*, and a selectable marker gene (*SMG*) that is under the control of eukaryotic promoter (*p*), polyadenylation (*pa*), and termination of transcription (TT) sequences.

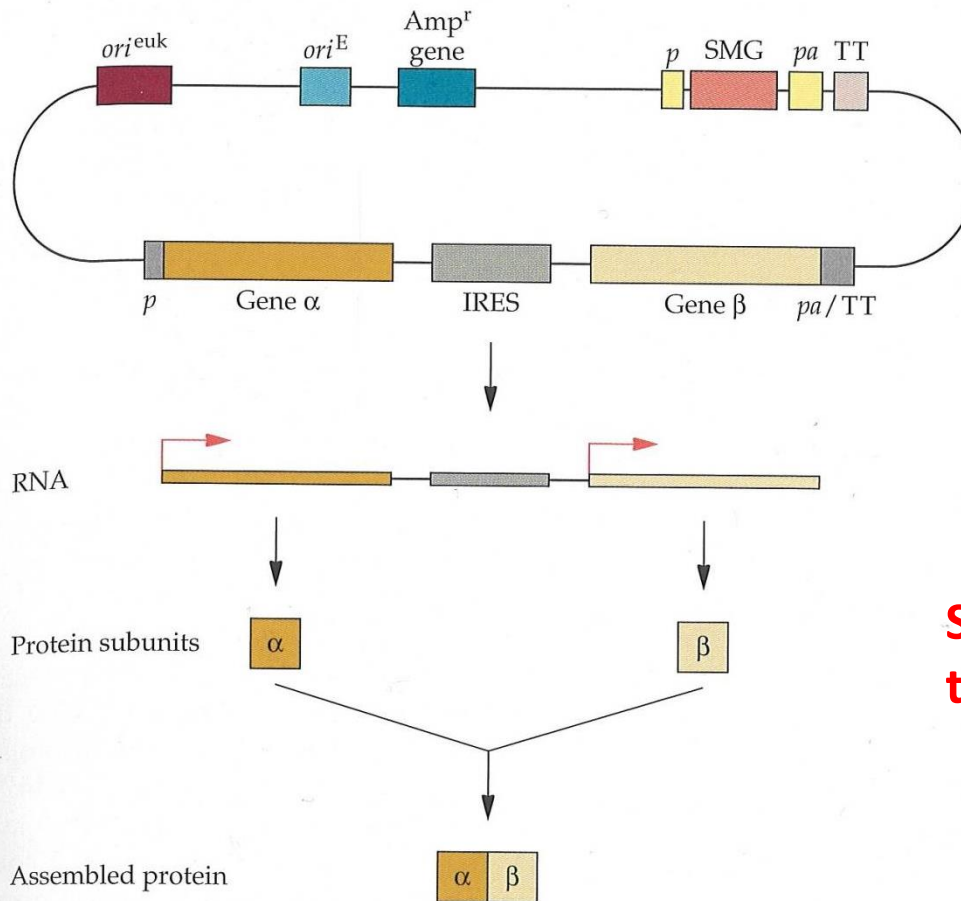

IRES:

Internal Ribosome
Entry Site

**Simultaneous expression of
two polypeptides**

FIGURE 7.27 Bicistronic expression vector. The cloned genes (gene α and gene β) encode subunits of a protein dimer ($\alpha\beta$). Each cloned gene is inserted into a vector on either side of a sequence for an IRES. The two genes and the IRES sequence form a transcription unit under the control of a single eukaryotic promoter (*p*), polyadenylation (*pa*), and termination of transcription (*TT*) sequence. Translation of the mRNA occurs from the 5' end and internally (right-angled arrows). Both subunits (α and β) are synthesized and assembled into a functional protein dimer ($\alpha\beta$). The vector carries origins of replication for *E. coli* (*ori^E*) and mammalian cells (*ori^{euk}*), a selectable marker (*Amp^r*) for selecting transformed *E. coli*, and a selectable marker gene (*SMG*) that is under the control of eukaryotic promoter (*p*), polyadenylation (*pa*), and termination of transcription (*TT*) sequences.

2.10.16